

# Interfacial effects from simulations of materials for organic electronics

Luca Muccioli

Dipartimento di Chimica Industriale  
“Toso Montanari”

University of Bologna

*ITN « Spins in Efficient Photovoltaic devices based on Organic Molecules »  
4th Network Wide Event, Mons (BE), April 8-12, 2019*

# Outline

1. molecular mechanics and molecular dynamics
  2. MD simulations of organic electronics materials: when, how, why?
  3. Examples
    - 2D and 3D Crystals (OFETs, sensors, ...)
    - Self-assembled monolayers (OFETs, sensors, electrodes, ...)
- Conclusions

# Part 1

molecular mechanics  
& molecular dynamics

# Model

**OED** | Oxford English Dictionary  
The definitive record of the English language

model, *n.* and *adj.*

8a: A simplified or idealized description or conception of a particular system, situation, or process, often in mathematical terms, that is put forward as a basis for theoretical or empirical understanding, or for calculations, predictions, etc.; a conceptual or mental representation of something.

## Molecular models

models aimed at reproducing the behavior of real molecules and chemical systems

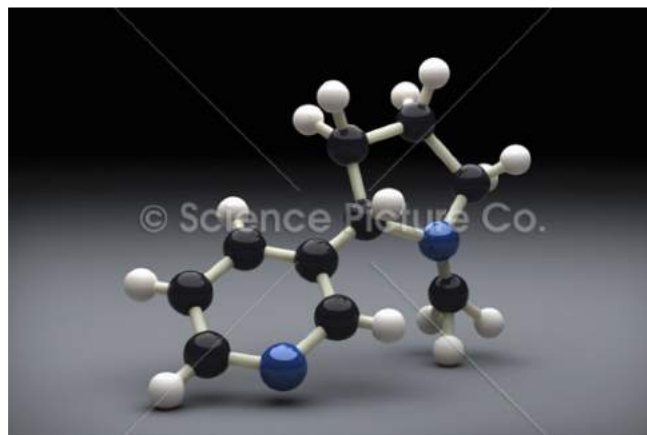

# Molecular models

- 3D structural models are interactive, and can be used for some basic modelling (e.g. conformational changes)
- One can also use simple real objects (“mechanical models”) to understand the packing of molecules

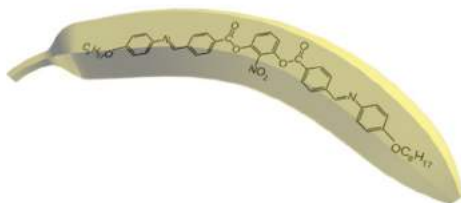
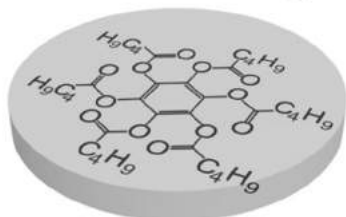
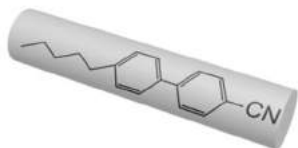

# Computer and theoretical models

- In practice, molecular modelling is nowadays invariably associated with computer modelling
  - Programming languages
  - Computer graphics and visualization
  - Parallel and high performance computing
  - National and European computing infrastructures



<https://www.cineca.it/en>

<http://www.hpc-europa.org/>

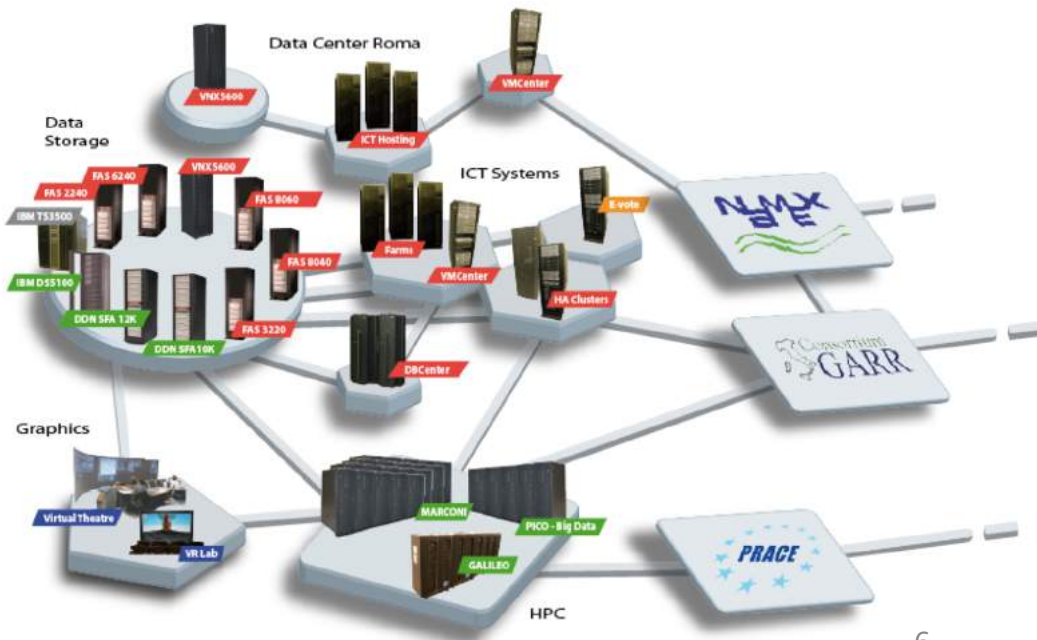

# Scales of molecular modeling

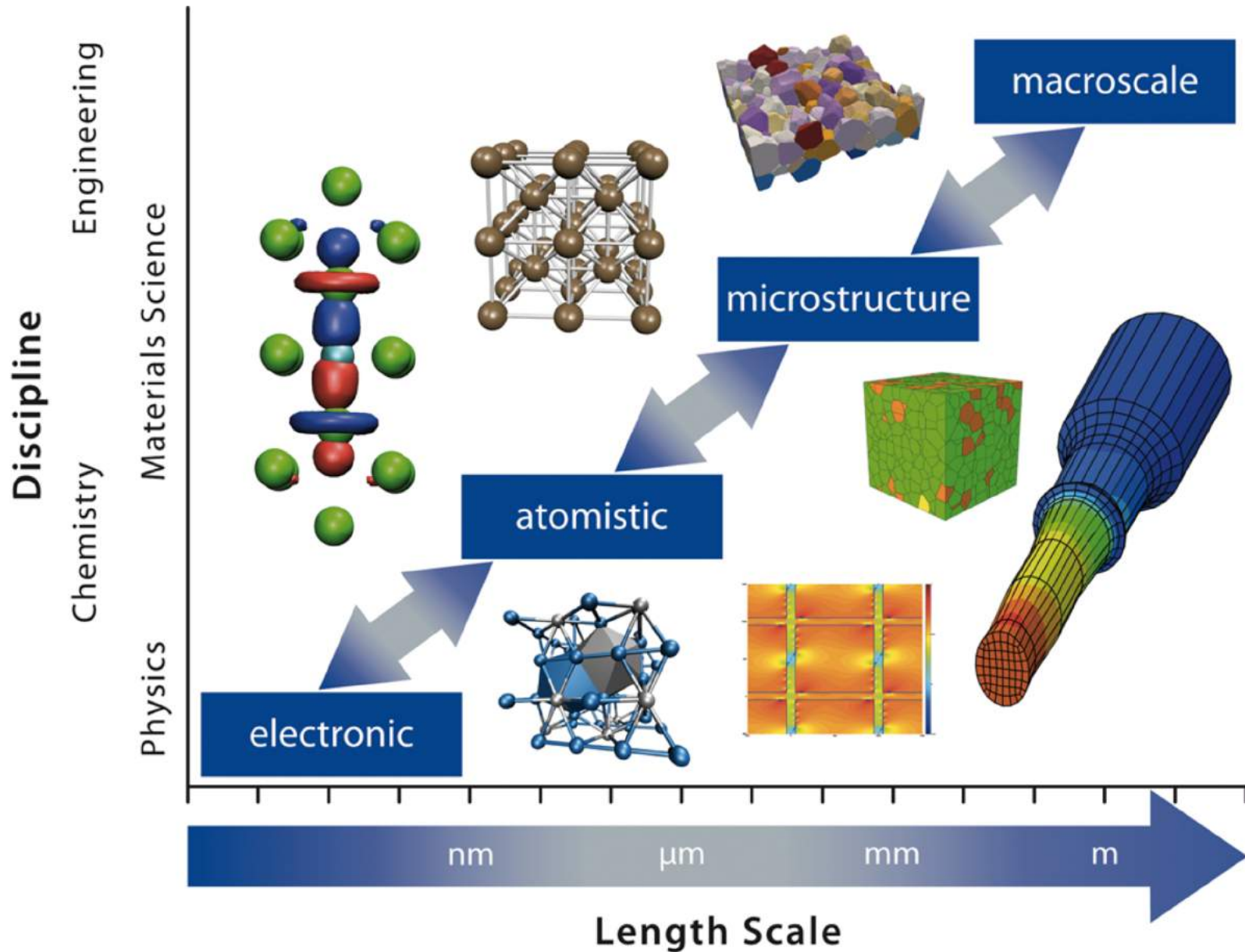

# Molecular mechanics

“beads and springs” model in which each bead is one atom

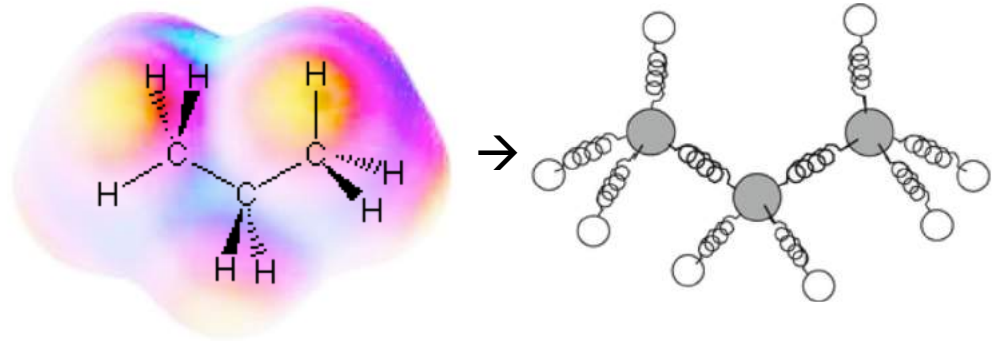

Molecular mechanics uses classical mechanics to model molecular systems (i.e. composed by atoms)

**Beads:** intermolecular forces

- London + repulsion
- point charges

**Springs:** intramolecular forces

- harmonic terms for stretching and bending
- cosines for torsions



# A molecular mechanics force field

FORCE FIELD = ENERGY EQUATION + PARAMETERS

$$U_{\text{total}} = \left[ \sum_{\text{bonds}} K_r (r - r_{\text{eq}})^2 + \sum_{\text{angles}} K_\theta (\theta - \theta_{\text{eq}})^2 + \sum_{\text{dihed}} \sum_{n=0}^6 V_n [1 + \cos(n\phi + \gamma)] \right] + \left[ \sum_{\text{atoms}}^{i < j} \left\{ \sqrt{\epsilon_i \epsilon_j} \left[ \left( \frac{\sigma_i + \sigma_j}{2r_{ij}} \right)^{12} - \left( \frac{\sigma_i + \sigma_j}{2r_{ij}} \right)^6 \right] + \frac{q_i q_j}{r_{ij}} \right\} \right]$$

intramolecular Interactions (bonded)

intermolecular Interactions (pairwise)

- empirical force field parameters aimed at reproducing experimental thermodynamic properties
- quantum-chemistry derived atomic charges
- mixing rules (intermolecular) can vary

# Intermolecular: LJ potential

Pairwise atom-atom interaction:  
**London + repulsive**

$$U(r) = 4\varepsilon \left[ \left( \frac{\sigma}{r} \right)^{12} - \left( \frac{\sigma}{r} \right)^6 \right] =$$
$$= \varepsilon \left[ \left( \frac{r_{min}}{r} \right)^{12} - 2 \left( \frac{r_{min}}{r} \right)^6 \right]$$

$$F(r) = -\frac{24\varepsilon}{r} \left[ 2 \left( \frac{\sigma}{r} \right)^{12} - \left( \frac{\sigma}{r} \right)^6 \right]$$

Very accurate for noble gases

**EMPIRICAL PARAMETERS**

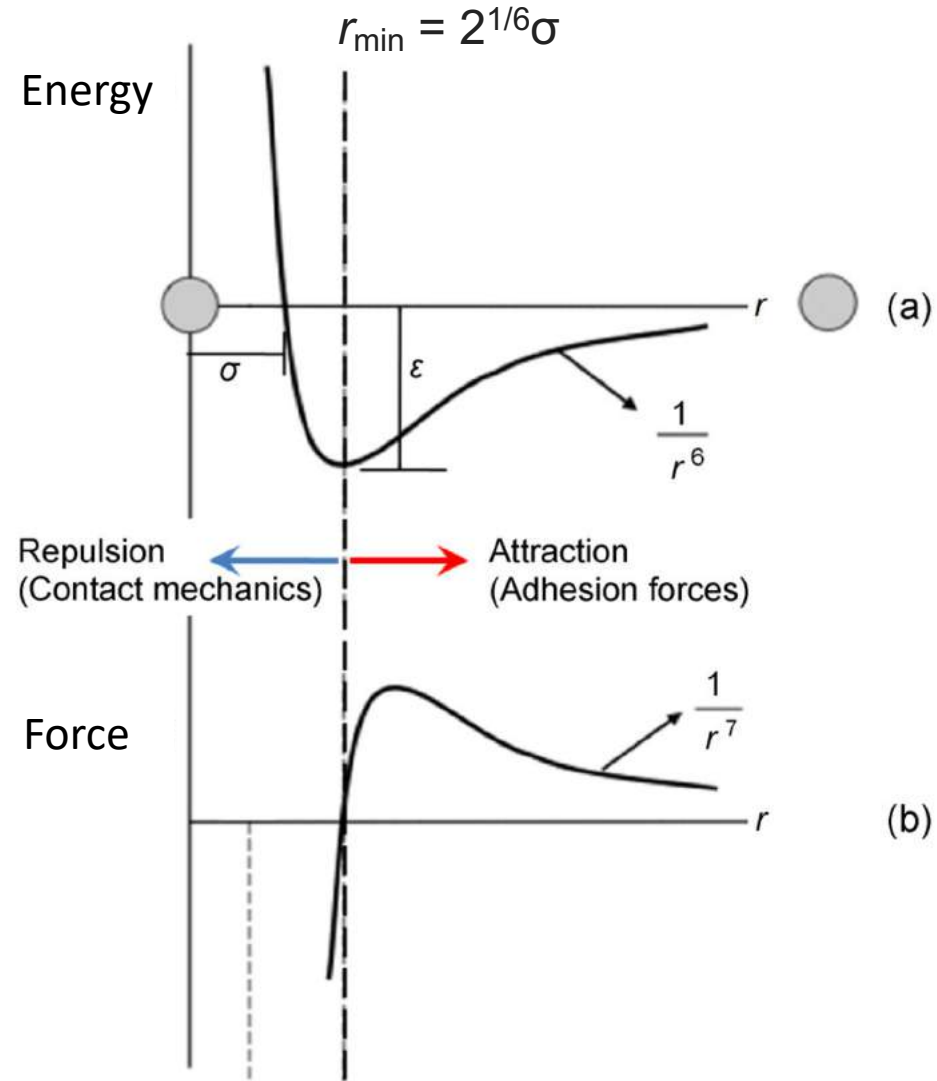

# Intermolecular: Coulomb

Electrostatic pairwise atom-atom interactions (**no polarization**)

atomic point charge approximation for charge densities

*ab initio*

*point charges*

$$q = Z_{\text{nucleus}} + q_{\text{electrons}}$$

$>0$                        $<0$

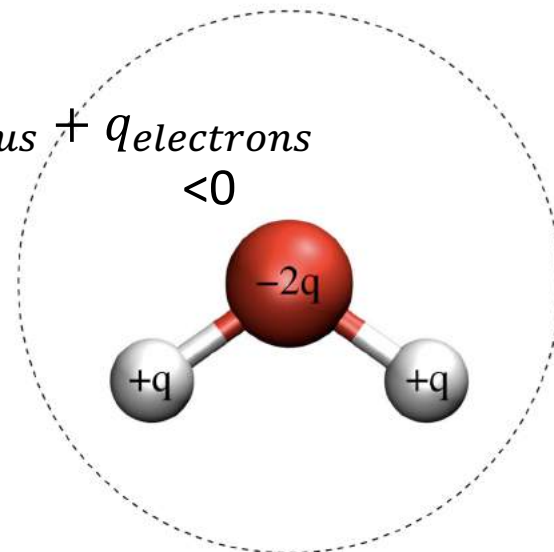
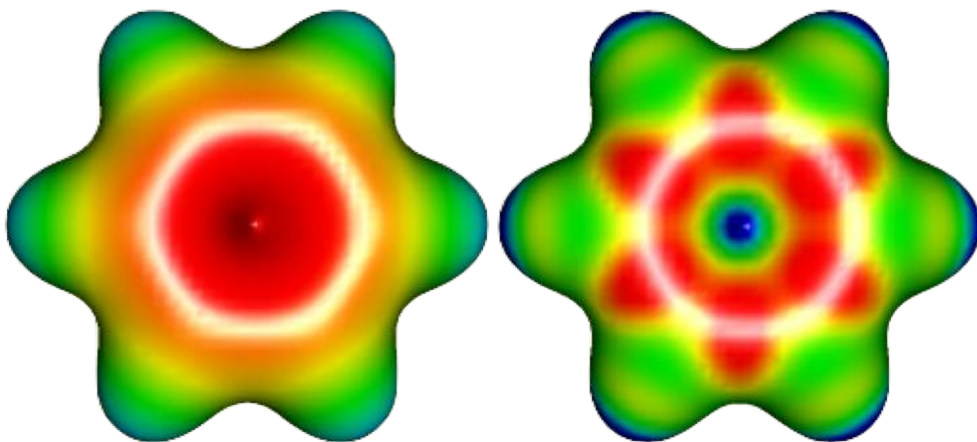

Point charges  $\rightarrow$  Coulomb's law  
(relative permittivity =1)

$$U_{ij} = \frac{1}{4\pi\epsilon_0} \frac{q_i q_j}{r_{ij}} \quad F_{ij} = -\frac{1}{4\pi\epsilon_0} \frac{q_i q_j}{r_{ij}^2}$$

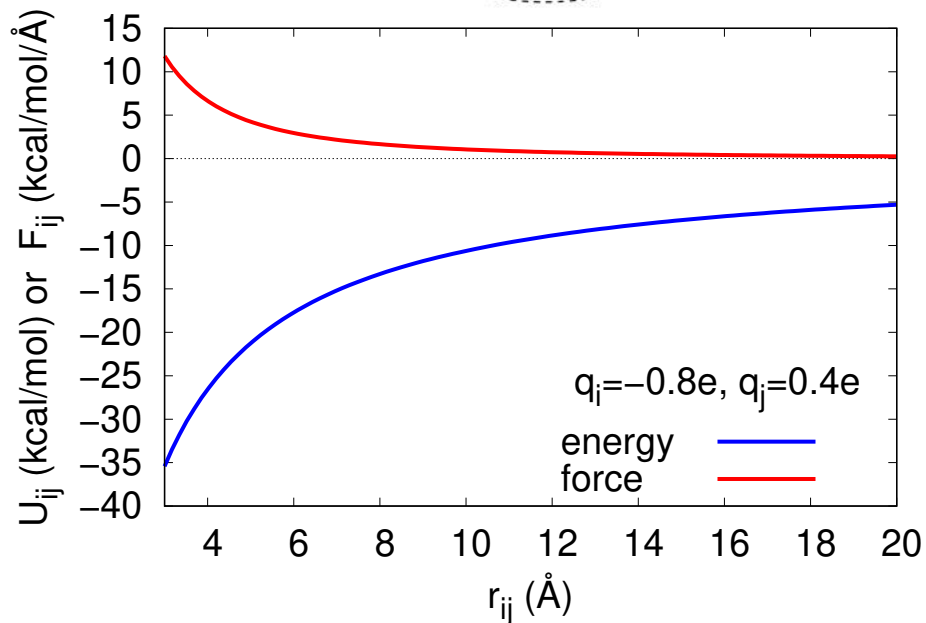

# Adding flexibility: springs (harmonic)

Harmonic springs replace chemical bonds:

- Bond distances

$$U(r) = \frac{1}{2} k_r (r - r_{eq})^2 \quad F(r) = -k_r (r - r_{eq})$$

- Bond angles

$$U(\theta) = \frac{1}{2} k_\theta (\theta - \theta_{eq})^2 \quad F(\theta) = -k_\theta (\theta - \theta_{eq})$$

“Transferable”: one uses always the same parameters for a given chemical bond type (e.g. C=O, >N-H, -OH, ... )

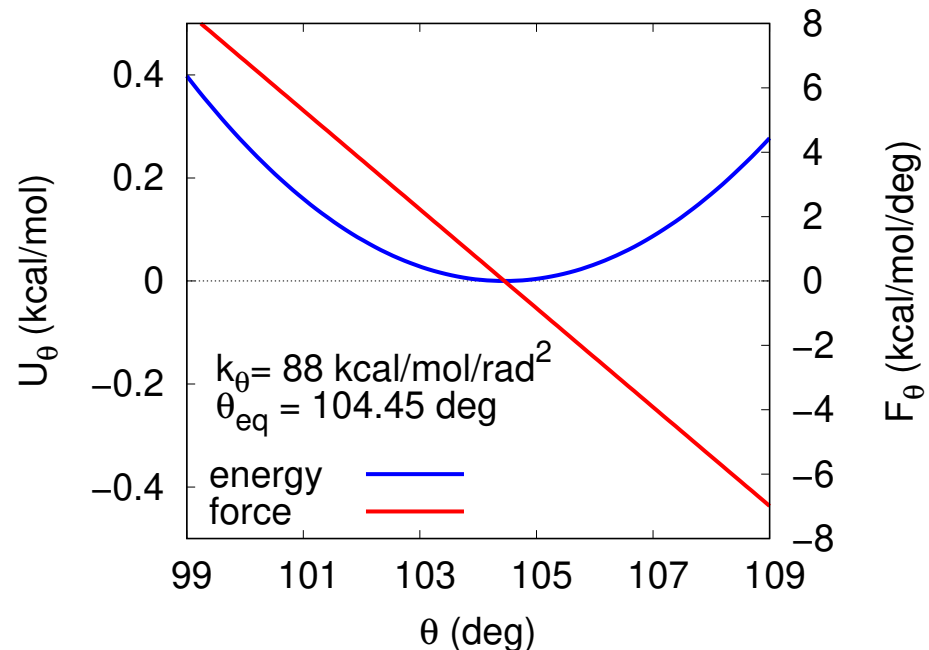
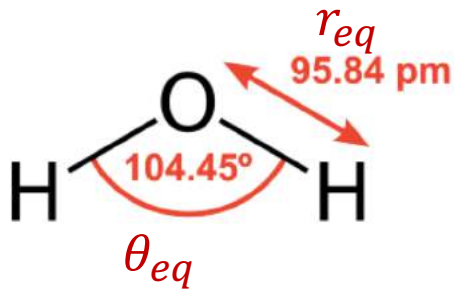

# Adding flexibility: torsions (anharmonic)

Rotation between rigid fragments are modelled with torsional potentials, of the form:

$$U(\varphi) = \sum k_{\varphi,n} [1 + \cos(n\varphi + \gamma_n)]$$

- Typically not transferable / must be verified
- Often re-parametrized vs quantum chemistry calculation

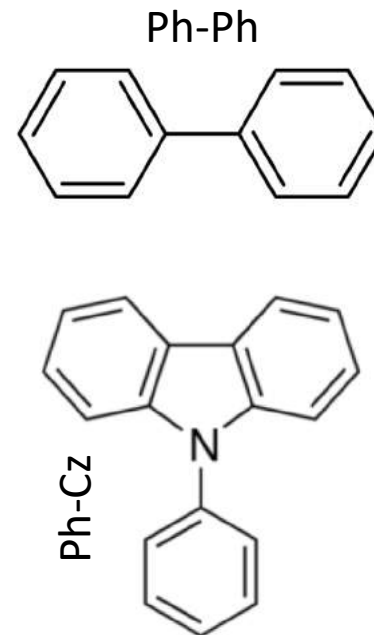
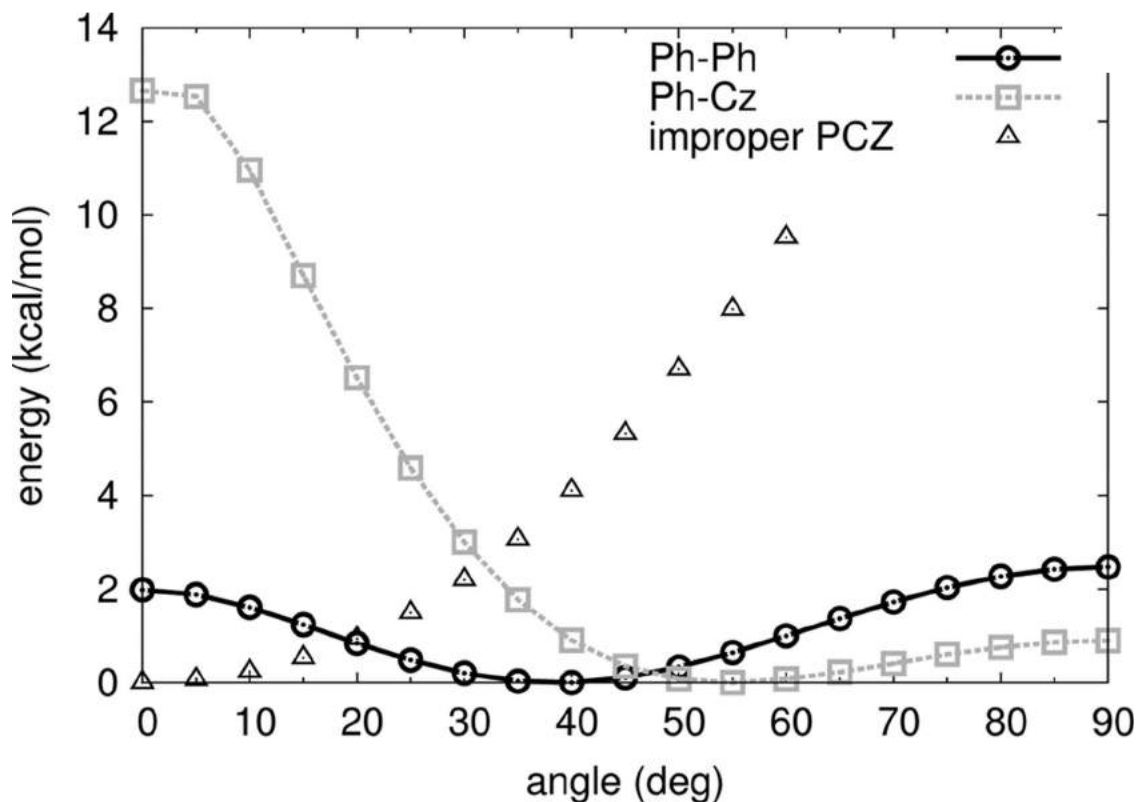
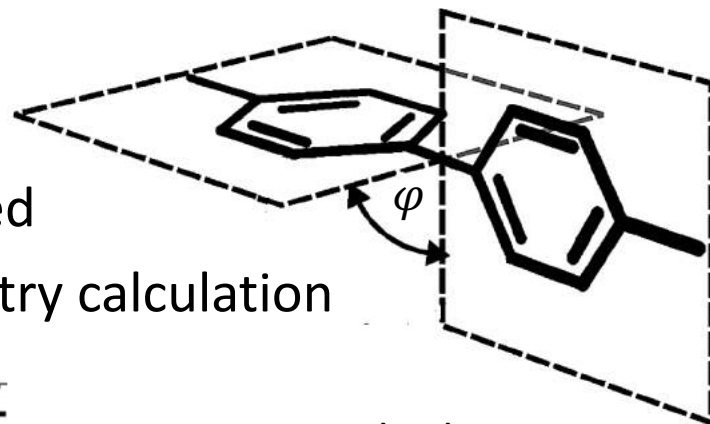

# Computing forces from energies

- In one dimension, the force  $F$  is the negative of the derivative of the total energy  $U$ :

$$F_x = -\frac{dU(x)}{dx}$$

- In 3D, it is the negative of the gradient:

$$\vec{F} = -\nabla U(x, y, z) = \left( -\frac{\partial U}{\partial x}, -\frac{\partial U}{\partial y}, -\frac{\partial U}{\partial z} \right)$$

- The net force is thus zero where the energy is at minimum; here we have a stable configuration.
- Forces should be computed for all atomic pairs  $\rightarrow$  core of the MD computation

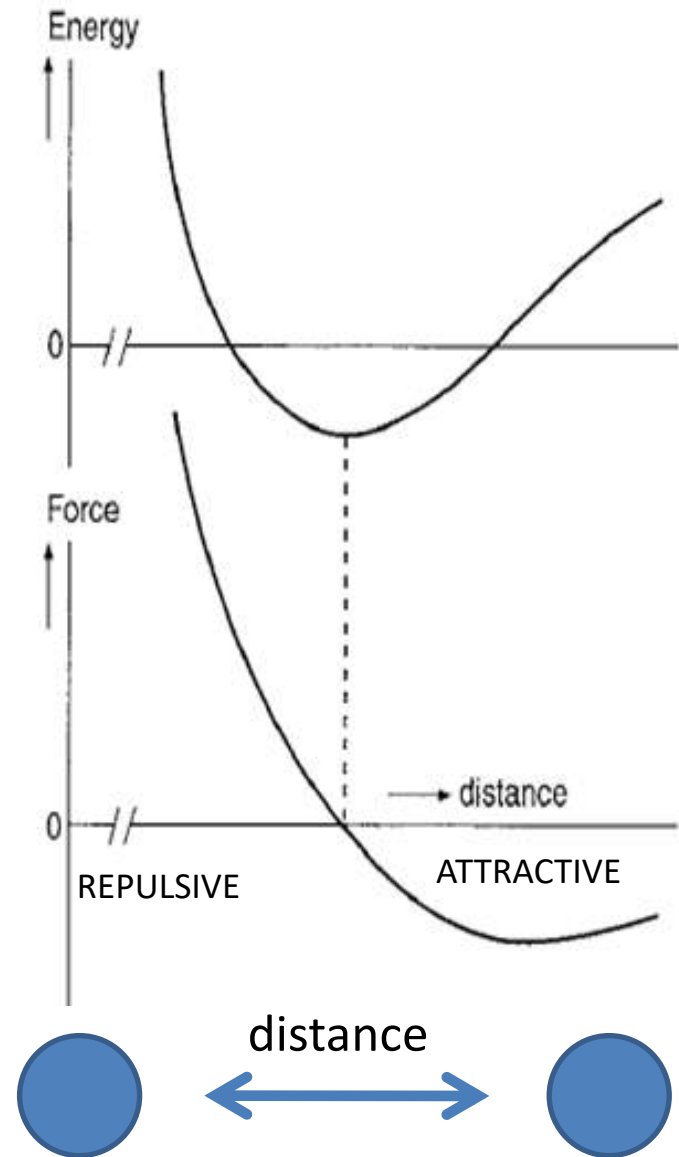

# Molecular dynamics

Once selected the potential energy function ( $V(r)$ ) and defined the system size and volume, MD consists in **solving numerically Newton's equations of motion for each of the particles.**

Timestep:  $\Delta t$  (typically 1 fs)

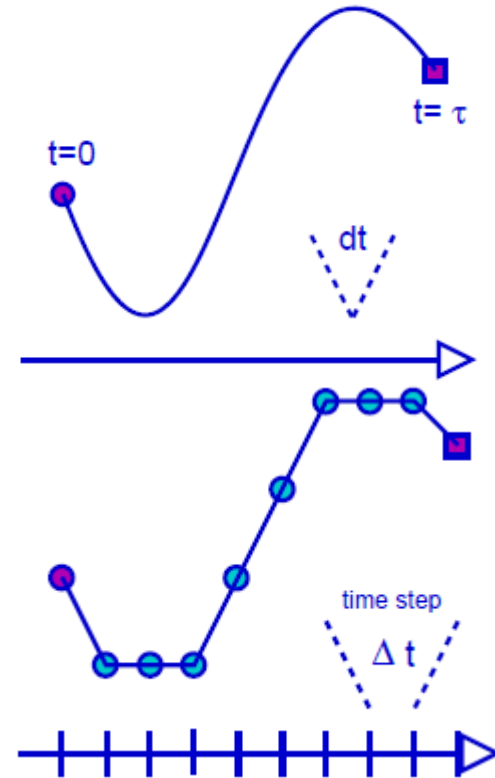
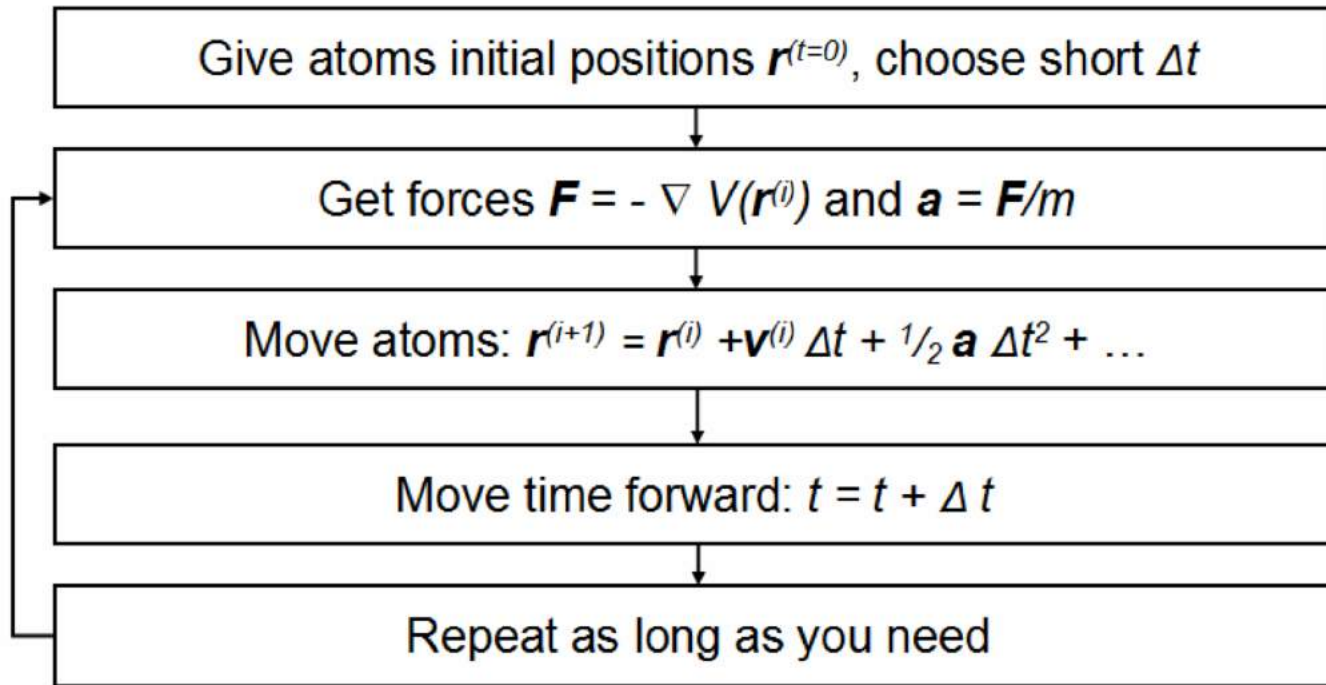

**Temperature** enters the system as the kinetic energy and is controlled by scaling particle velocities:

$$3/2 k_B T = 1/2 \langle m \mathbf{v}^2 \rangle \rightarrow T = \langle m \mathbf{v}^2 \rangle / (3k_B)$$

**Pressure** is given by kinetic energy and forces  $p = \frac{1}{V} \left[ Nk_B T + \frac{1}{3} \langle \sum_{i=1}^N \mathbf{r}_i \cdot \mathbf{F}_i \rangle \right]$

# Ensemble and time averages

$A(t)=A(\mathbf{p}^N(t),\mathbf{r}^N(t))$  is a generic property varying over time and depending from the  $N$  momenta  $\mathbf{p}^N(t)$  and positions  $\mathbf{r}^N(t)$  of the particles.

**ensemble:** collection of all points  $\{\mathbf{p}^N,\mathbf{r}^N\}$  in the  $6N$ -dimensional phase space The points are distributed according to a **probability density function**  $\rho$ , which is determined by the chosen fixed macroscopic parameters defining the system (NPT, NVT, NVE, etc.).

The **ensemble average**  $\langle \rangle$  of  $A$  is defined by the integral over all possible configurations of the system *at a fixed time*, using the pdf  $\rho(\Gamma)$  as weight:

$$\langle A \rangle = \iint d\mathbf{p}^N d\mathbf{r}^N A(\mathbf{p}^N, \mathbf{r}^N) \rho(\mathbf{p}^N, \mathbf{r}^N)$$

in NVT conditions  $\rho(\mathbf{p}^N, \mathbf{r}^N)$  is the familiar Boltzmann distribution:

$$\rho(\mathbf{p}^N, \mathbf{r}^N) = \exp(-E(\mathbf{p}^N, \mathbf{r}^N)/k_B T) / Q$$

We define instead as **time average** an average quantity for a single system over a time interval (directly related to a real experimental measure):

$$\langle A \rangle = \lim_{\tau \rightarrow \infty} \frac{1}{\tau} \int_0^\tau dt A[\mathbf{r}(t), \mathbf{p}(t)]$$

In MD simulations we are integrating the equation of motion of the system to determine  $A(\mathbf{p}^N(t), \mathbf{r}^N(t))$  at each time  $t$ .

$$\langle A \rangle \approx \frac{1}{N_t} \sum_{n=1}^{N_t} A(n\Delta t)$$



# Ergodicity

A system is called «ergodic» if time average and ensemble average coincide.

In an ergodic system all possible trajectories would be, in practice, different sections of a single long trajectory → initial conditions do not matter

**We conduct most simulations in the hypothesis of ergodicity.**

If this hypothesis is not respected and we do not realize it, we might reach wrong conclusions.

## Causes of non-ergodicity:

- metastable states
- too high free energy barriers
- temperature too low
- “unfortunate” initial configuration
- Simulation is not long enough
- Free energy landscape is “rough”

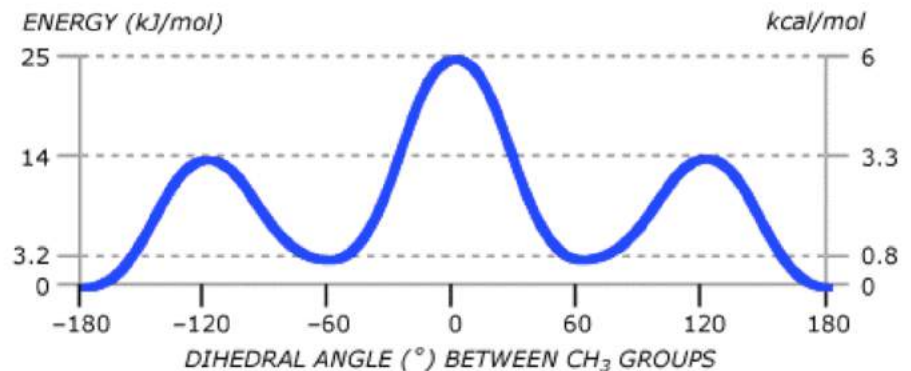
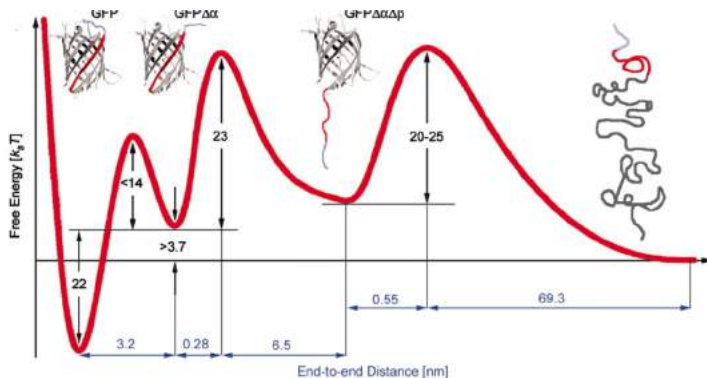
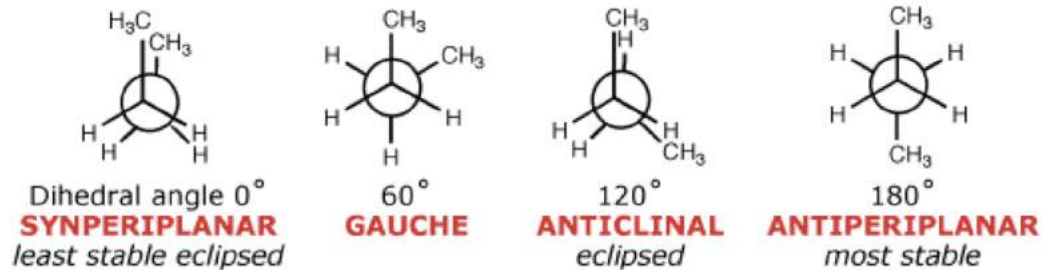

Rule of thumb: only barriers lower than 5-6 kcal/mol can be surpassed in 10 ns at RT. 17

# Part 2

MD simulations of organic  
electronics materials:  
when, how, why?

# Why performing atomistic simulations?

Generally speaking:

→ obtain structure → compute physical properties

Three typical cases:

1. I have a guess structure and want to check if it is stable or show that it is stable  
*(scientifically risky before often one gets what she/he wants...)*
2. The experimental structure is known but I want include thermal effects  
*(sometimes does not work → force field or experimental issues)*
3. The structure is obtained “spontaneously” via self assembling  
*(most interesting and demanding, often unsuccessful)*

# Practical limitations

Simulations can provide nanoscopic details difficult to obtain from experiments.  
However...



- the number of simulated particles ( $\sim 10^6$ ) is much smaller than in a “macroscopic system”.
- the trajectory length ( $10^{-6}$  s) is relatively short with respect to real experiments.

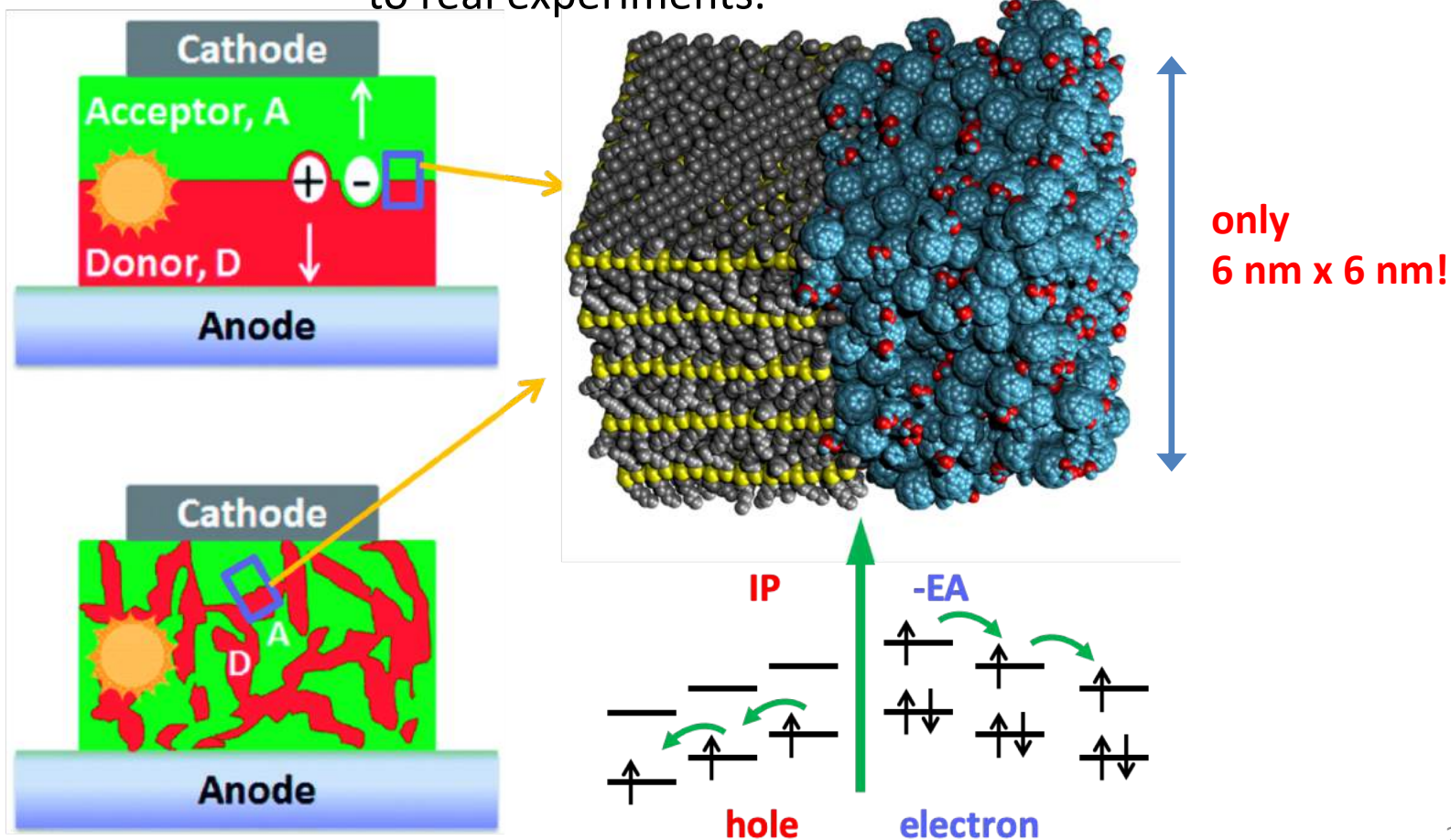

# Atomistic simulations of organic electronic materials: when and why

When: each time a periodic quantum chemistry calculation is not possible (defects, disorder, ...) and a gas phase QC calculation is not enough (distributions, thermal averaging...)

Why: because we are interested in electronic properties and they strongly depend on molecular arrangement.

In fact:

→ Conformation, environment, surfaces strongly affect IP, EA, and in general electronic state energies

→ **Electronic couplings** vary very rapidly with distance and orientation

$$k_{ij} = \frac{2\pi}{\hbar} \frac{J_{ij}^2}{\sqrt{4\pi\lambda k_B T}} \exp\left[-\frac{(\Delta G_{ij} + \lambda)^2}{4\lambda k_B T}\right]$$

$$\mu(F, T) = \mu_\infty \exp\left[-\left(\frac{2\sigma}{3kT}\right)^2\right] \exp\left[C_0 \left(\left(\frac{\sigma}{kT}\right)^2 - \Sigma^2\right) \sqrt{F}\right]$$

charge transfer rate (Marcus)

mobility (Baessler)

# Possible effects at the interface

Organic electronic devices are governed by interfaces, at which electronic properties change with respect to the bulk of the material

Surfaces can determine the alignment  
“face on” / “edge on”

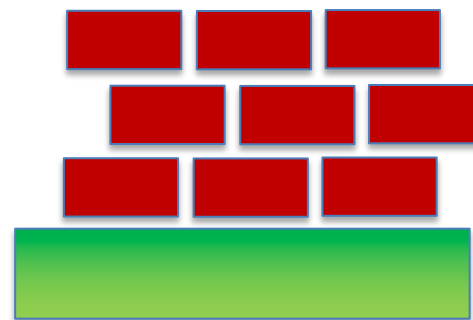
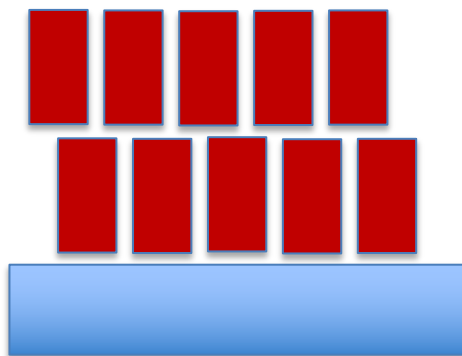

Surfaces can increase or decrease orientational and positional order

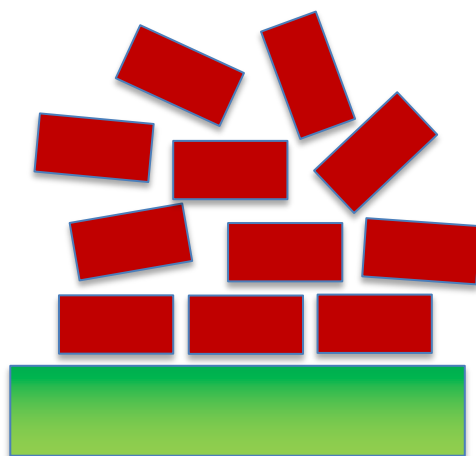

# Possible effects at the interface

Roughness,  
surface defects,  
templating

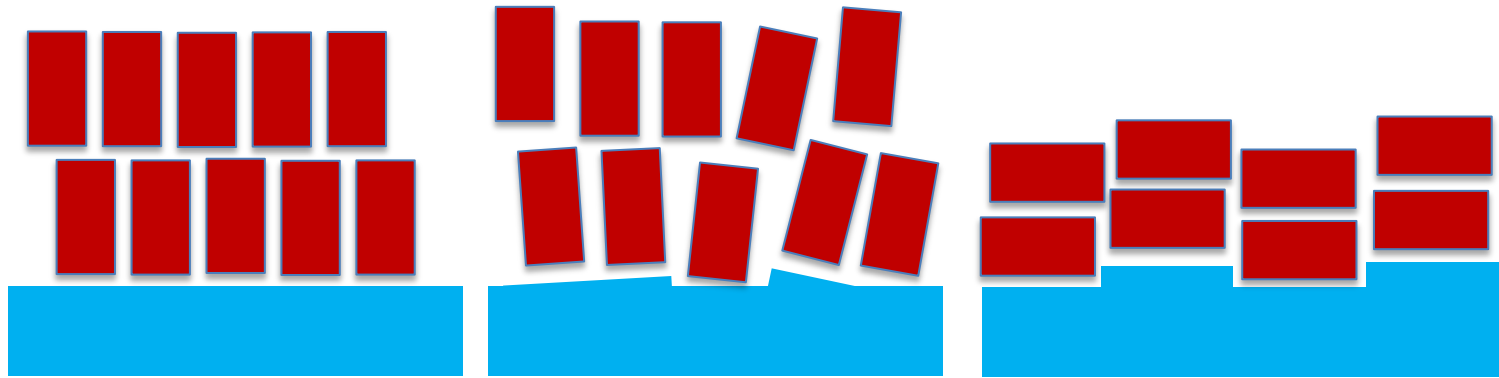

The same concepts  
apply to an interface  
between two  
molecular materials

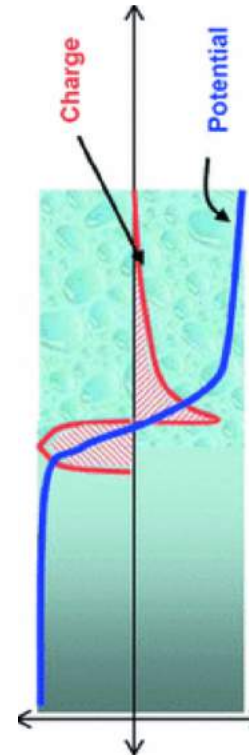
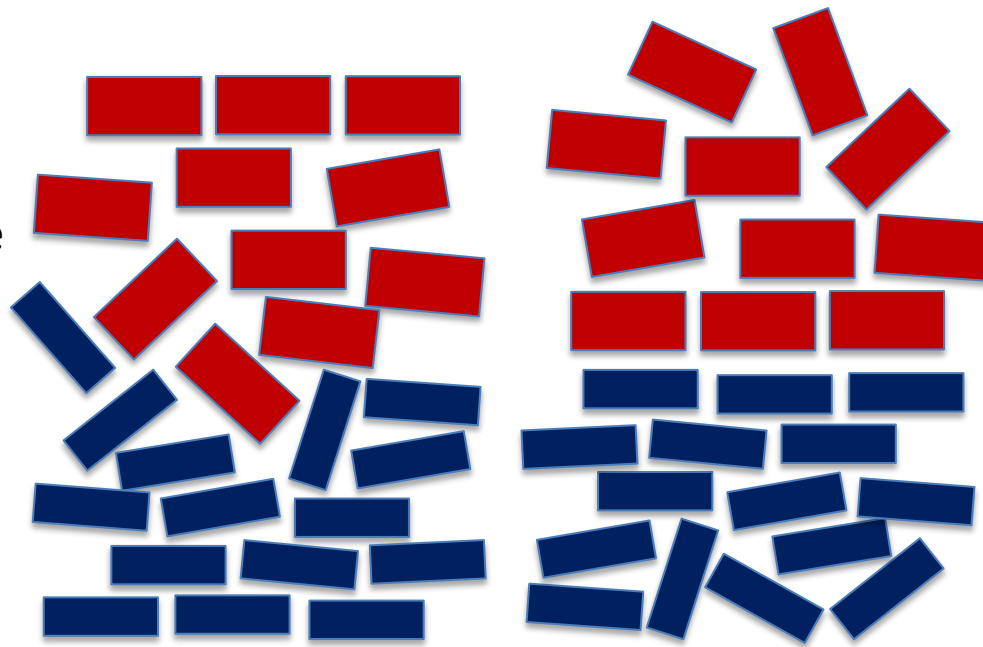

# Limitations for electronic property calculations from molecular mechanics structures

## PROBLEM

NO chemical reactions

Classical treatment of nuclei

*no zero point energy, tunneling, vibronic progressions, ...*

Bond lengths not so accurate

*no bond length alternation, systematic errors in polarizability and energy levels*

NO polarization

*inaccurate electrostatics for charged species*

## SOLUTION

reactive force fields

Senftle *npj Comput. Mater.* 2:15011 (2016)

mixed QM/MD

Cerezo *J. Phys. Chem. Lett.* 7:4891 (2016)

ring polymer dynamics

Habershon *Annu. Rev. Phys. Chem.* 64:387 (2013)

benchmarks for correcting systematic errors

QM-based force fields

Andreussi *J. Chem. Theory Comput.* 13:4636 (2017)

Microelectrostatics (postprocessing)

D'Avino *J. Chem. Theory Comput.* 10:4959 (2014)

Polarizable force fields (simulation)

Lemkel *Chem. Rev.* 116:4983 (2016)



# Multiscale modeling of organic electronics materials

(Beljonne Cornil D'Avino Muccioli Olivier & co)

## → "Realistic" morphologies

Atomistic Molecular

Dynamics – united atoms

(MD)

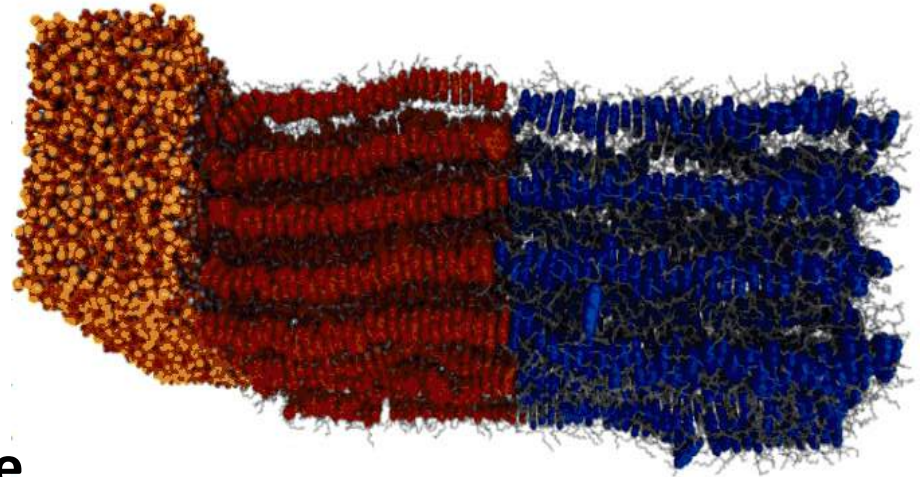

## → Molecular electronic structure

Quantum Chemistry

(DFT, AM1)

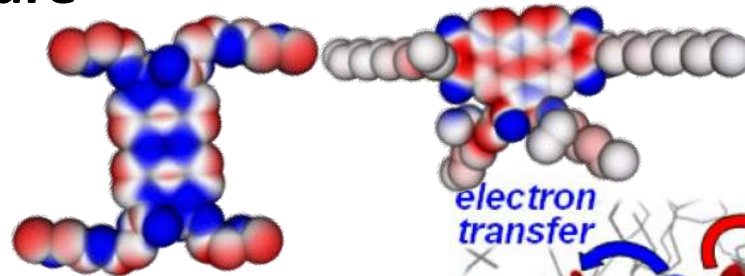

## → Kinetic models

Marcus theory for charge transfer, ...

## → Charge carrier energy landscape

Classical MicroElectrostatics

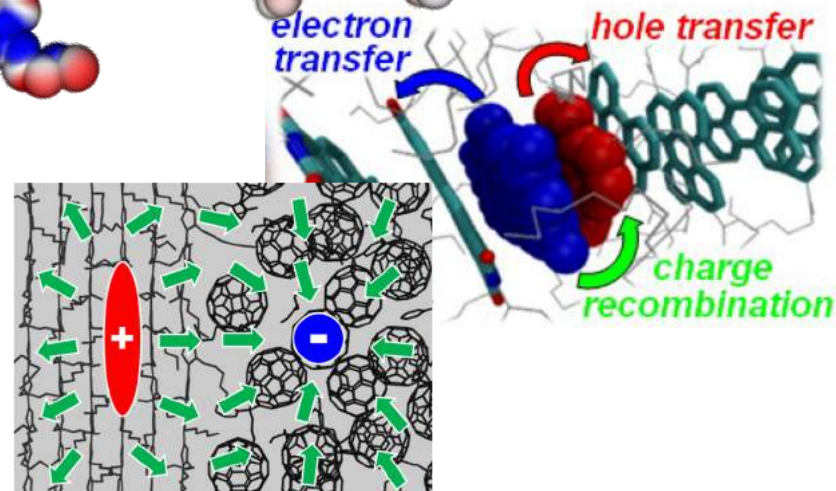

F. Castet [PhysChemChemPhys 16:20279 \(2014\)](#)

G. D'Avino [J. Phys.:Condens. Matter 28:433002 \(2016\)](#)

# Part 3

## Examples

2D and 3D Crystals (OFETs, sensors, ...)

Self-assembled monolayers  
(OFETs, sensors, electrodes, ... )

# 2D self-assembling: carbon nanorings on graphite

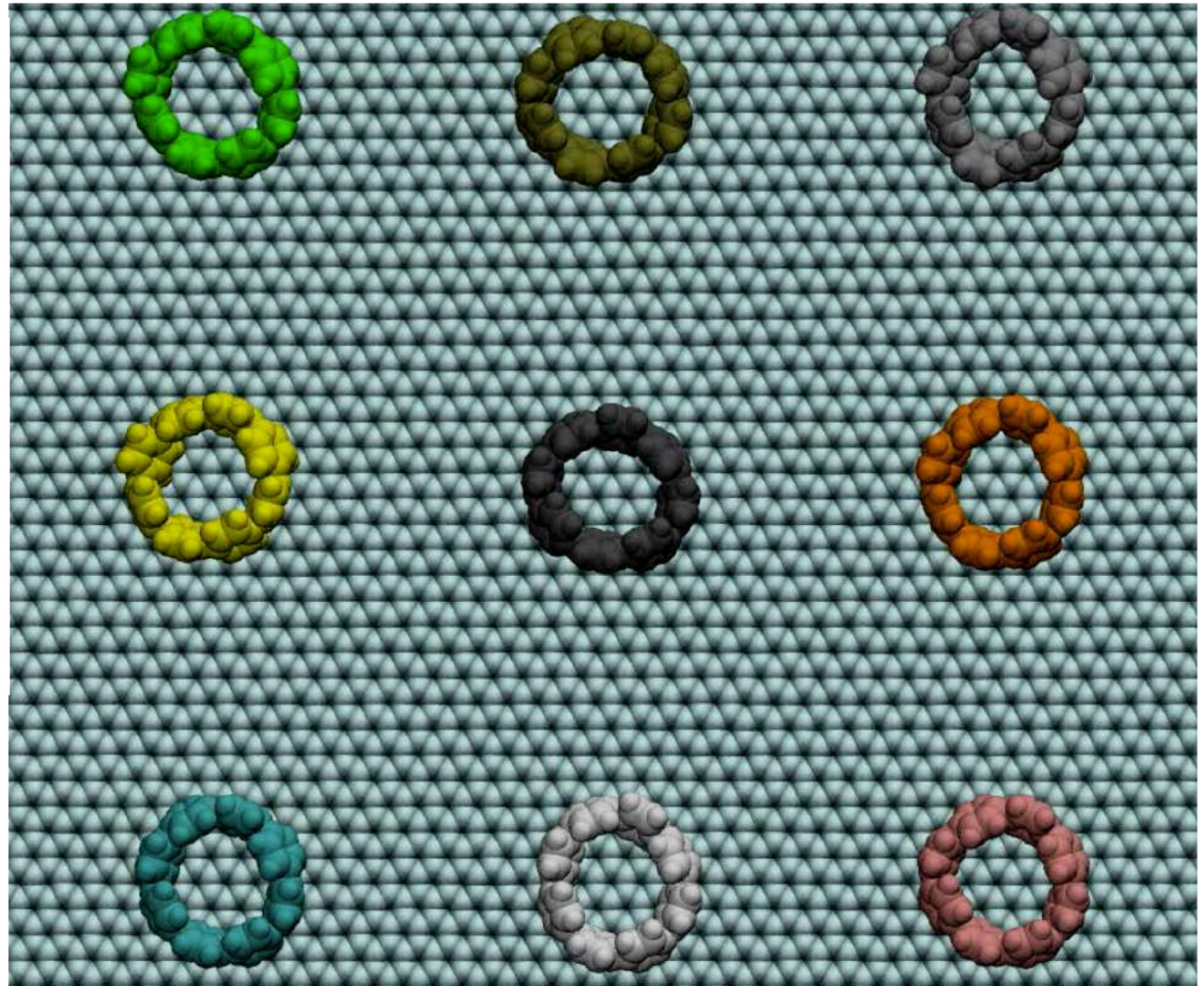
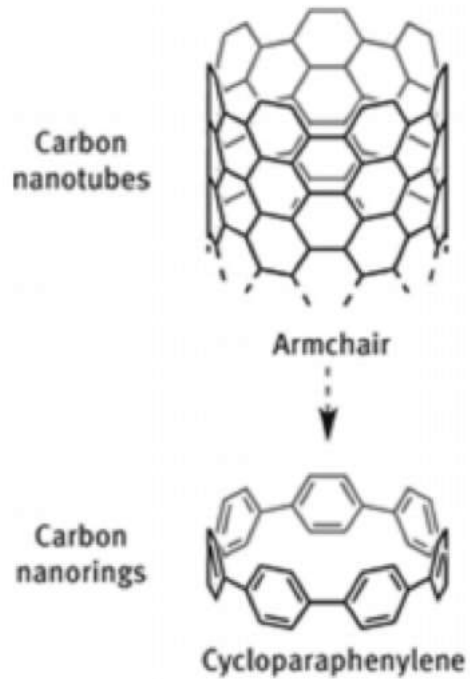



# Two different possible tiling identified

HEXAGONAL

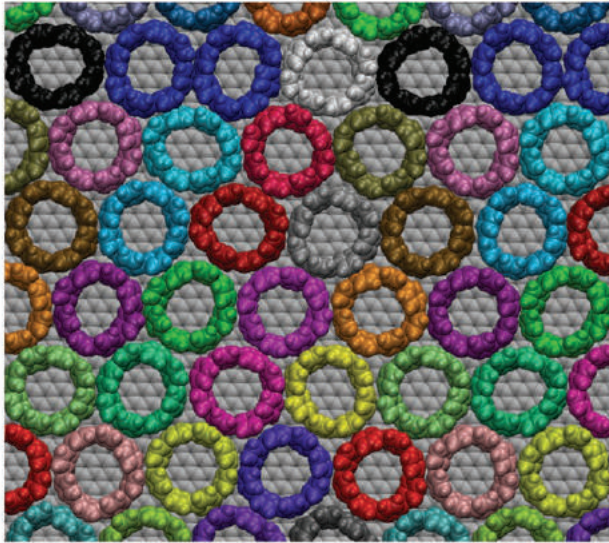

(c)

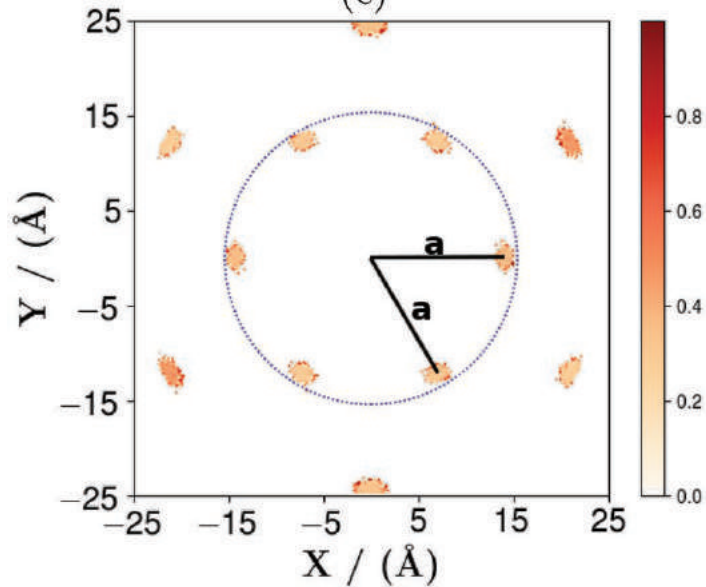

HERRINGBONE

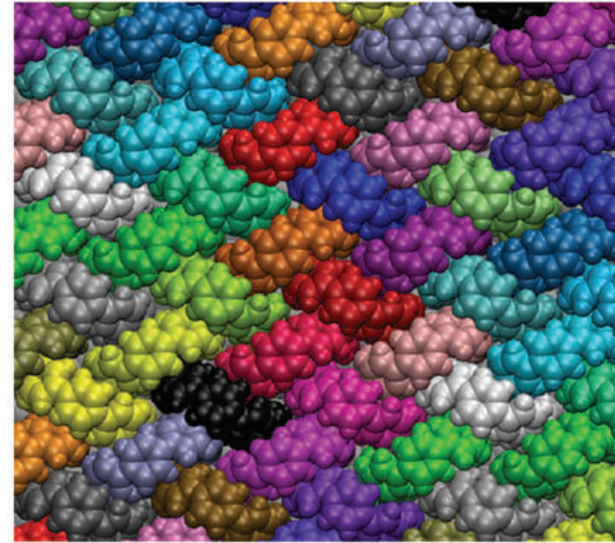

(d)

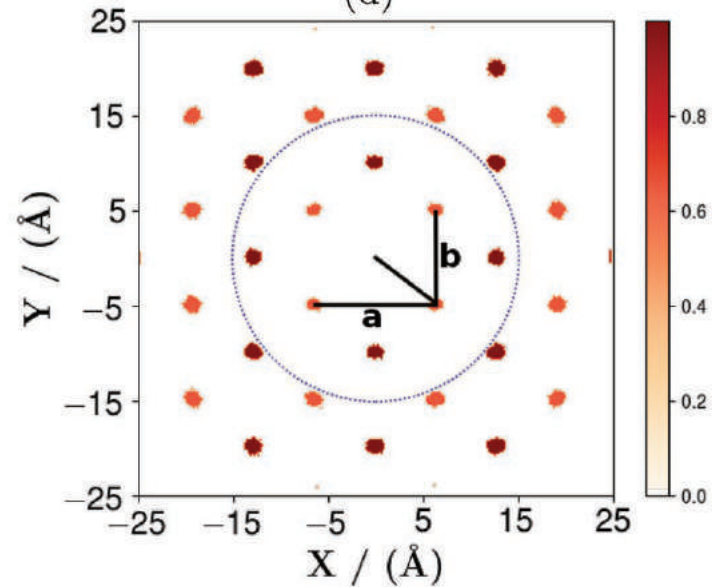

# Packing strongly affects mobility and its anisotropy

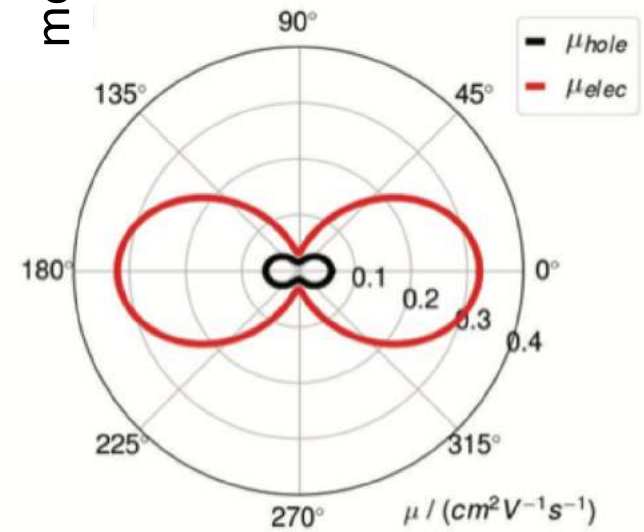
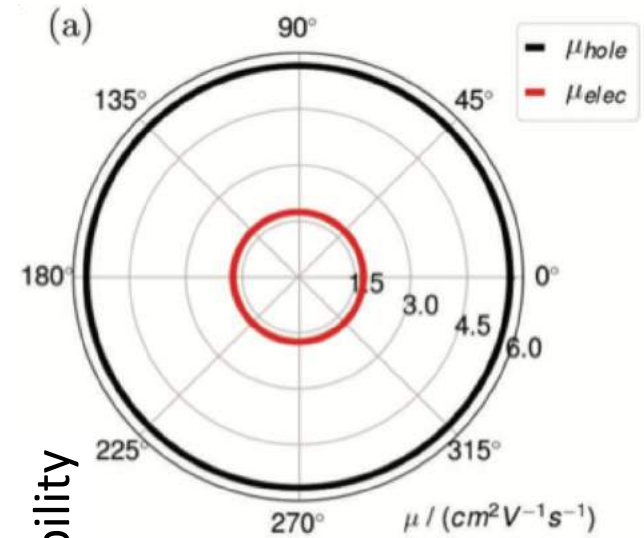
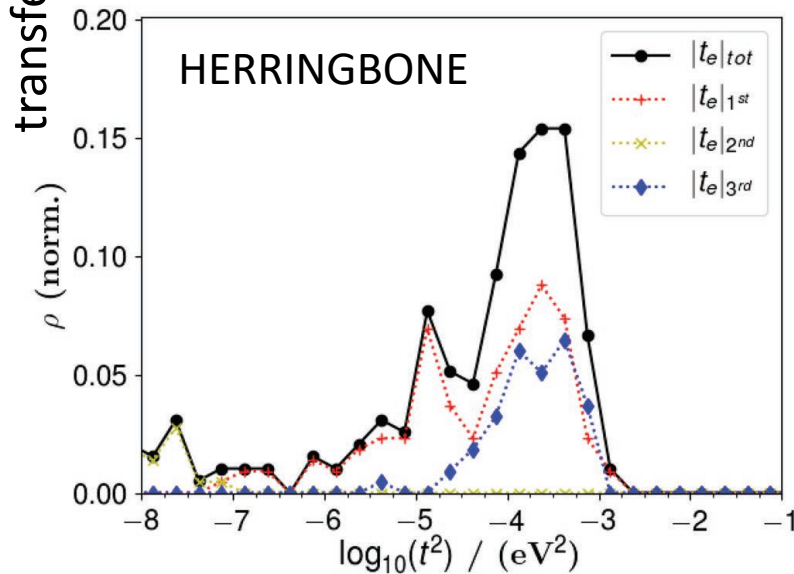
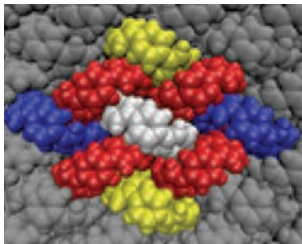
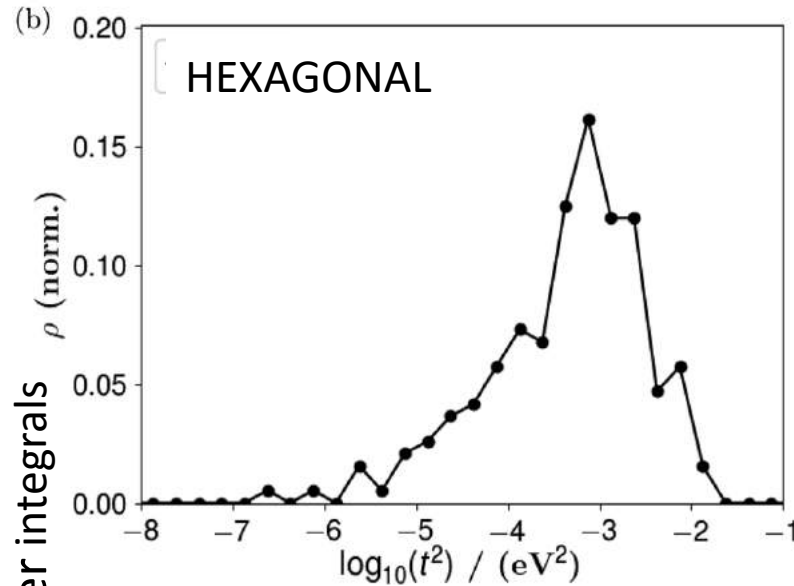
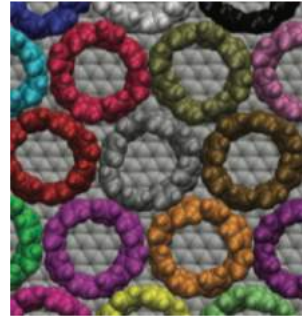

# 3D self-assembling: mimicking vapor (co)deposition

- A molecule is added to the sample every XXX ps
- Random specie selected with assigned probability
- Random initial position in the xy plane
- Vertical position  $\sim X0 \text{ \AA}$  above the surface
- Initial velocity  $(0,0,-v_z)$  directed to the surface
- high temperature (500 K)

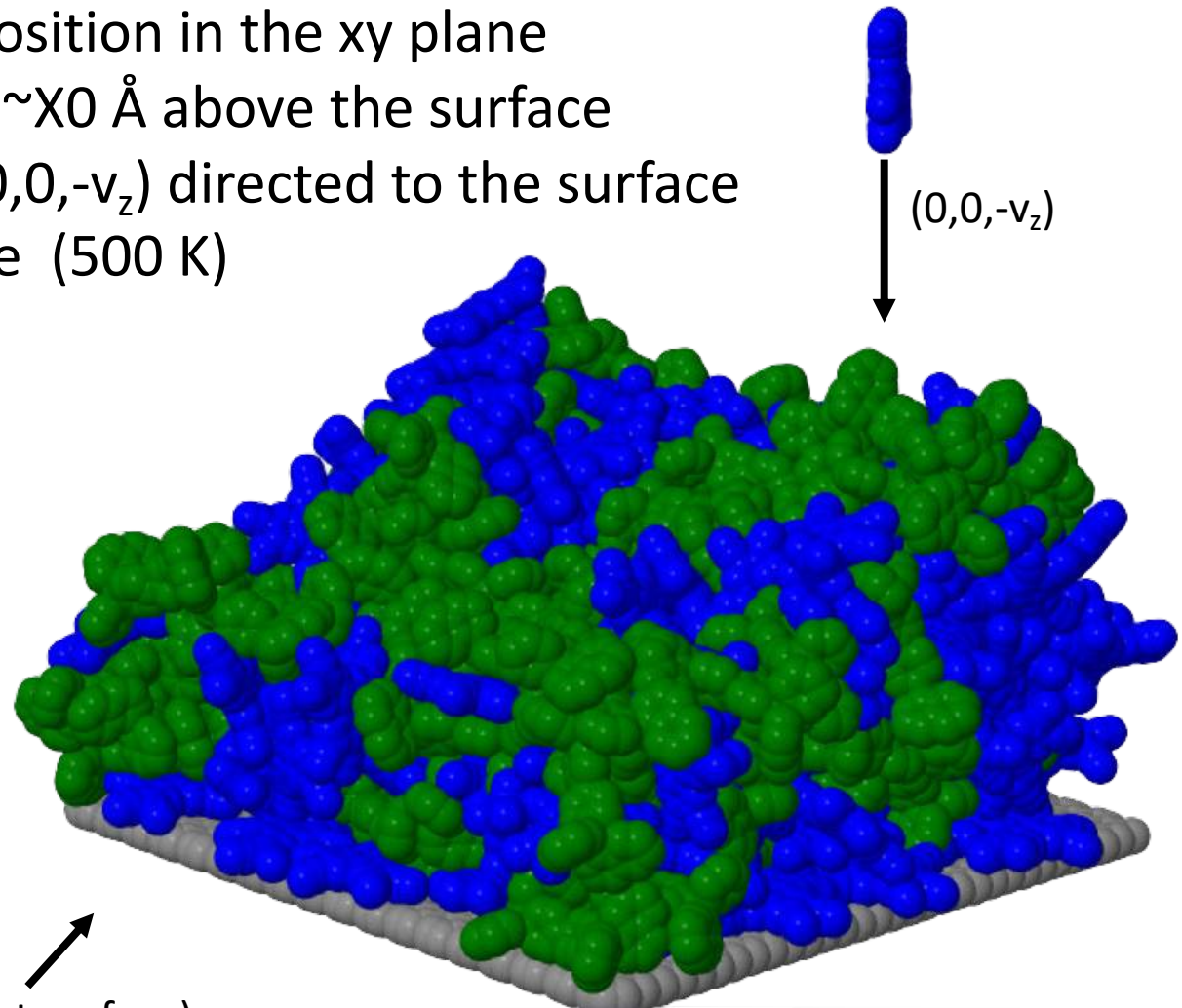

graphene (a flat support surface)



# vapor deposition of pentacene on C60

Non-equilibrium simulations in which new molecules are inserted in random positions at fixed time intervals

p-type

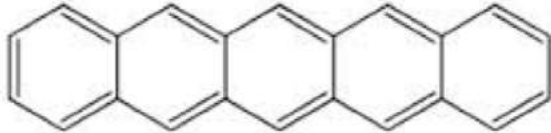

n-type

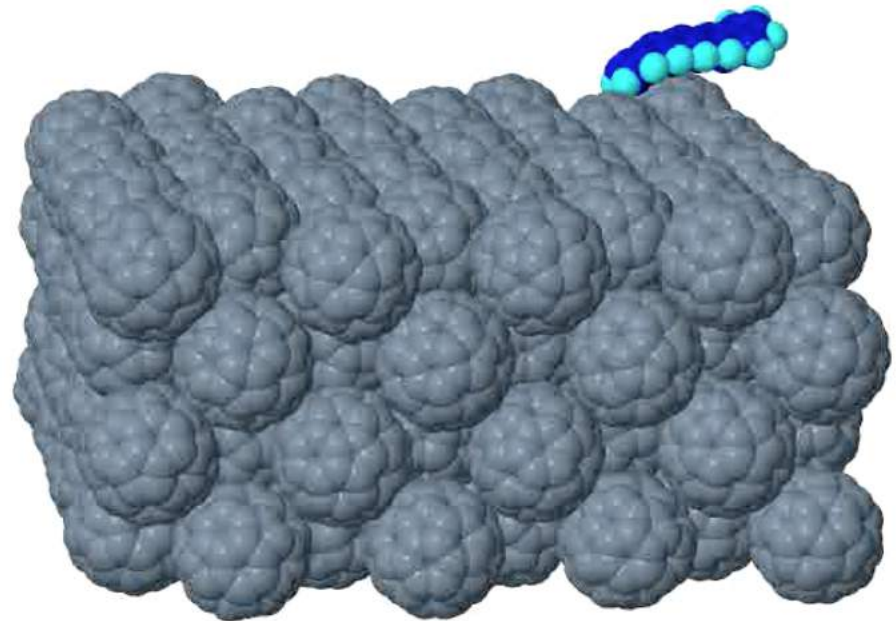
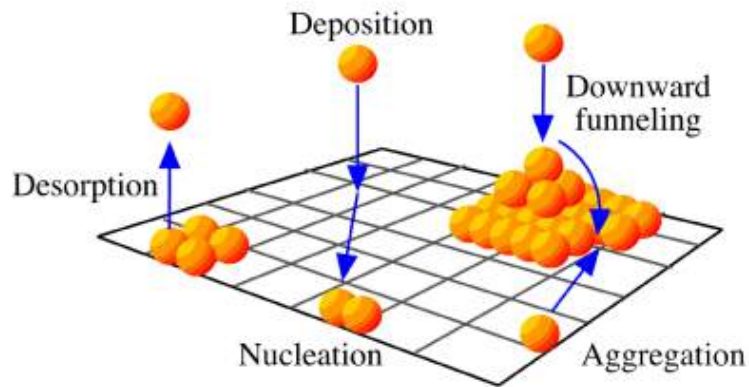

PENTACENE MOLECULES: 001

# Crystal growth of pentacene on silica

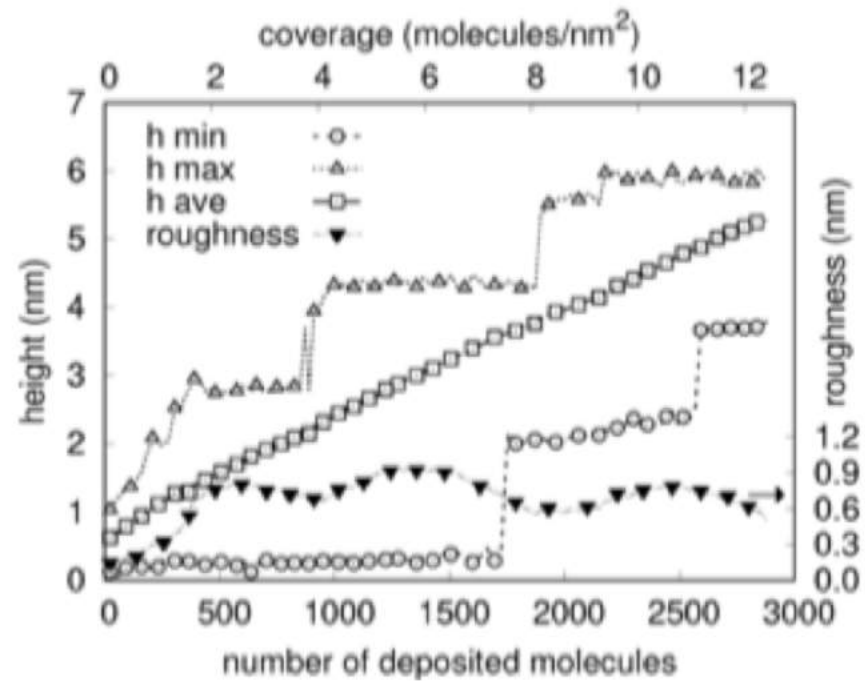
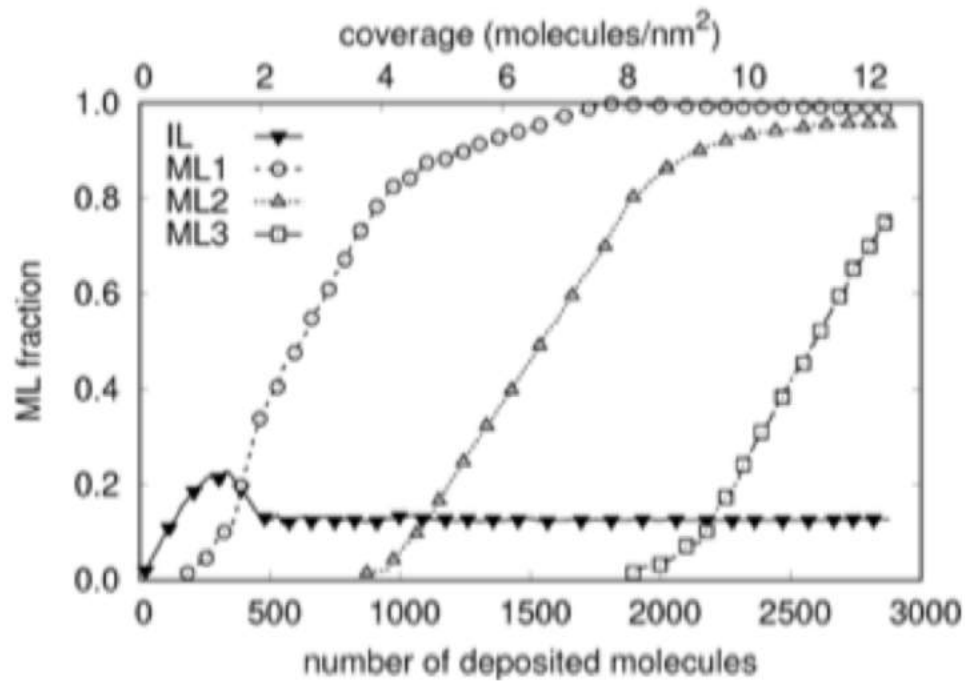
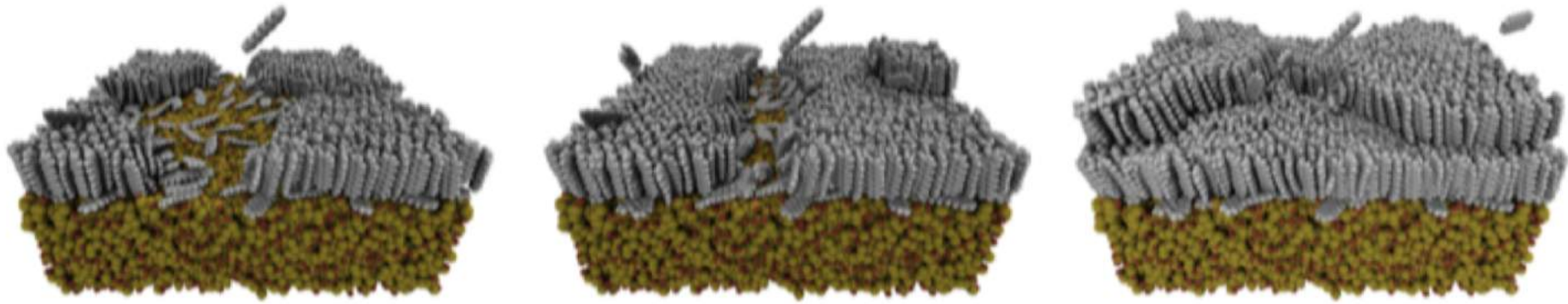



# Formation of a crystalline nucleus

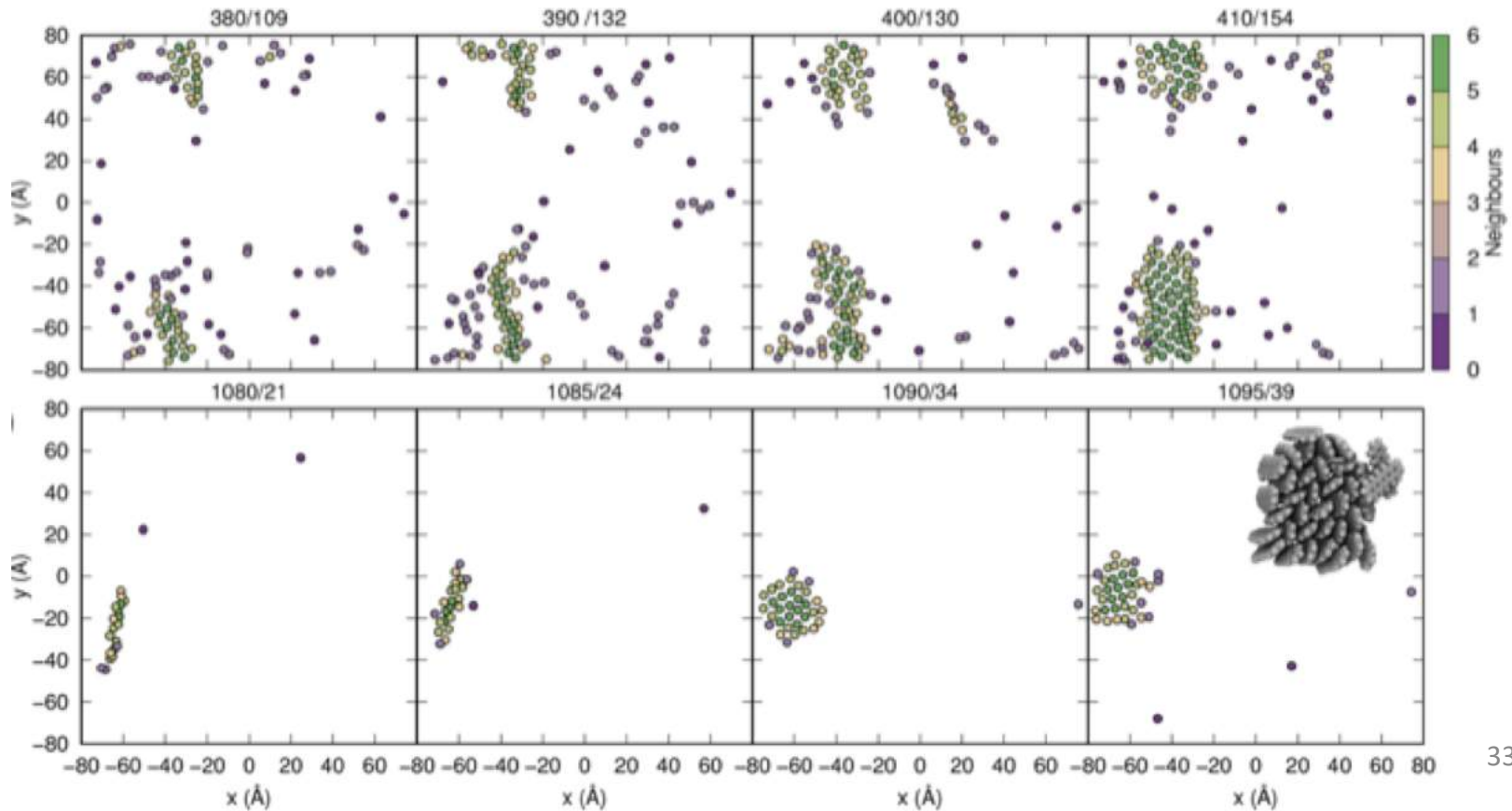
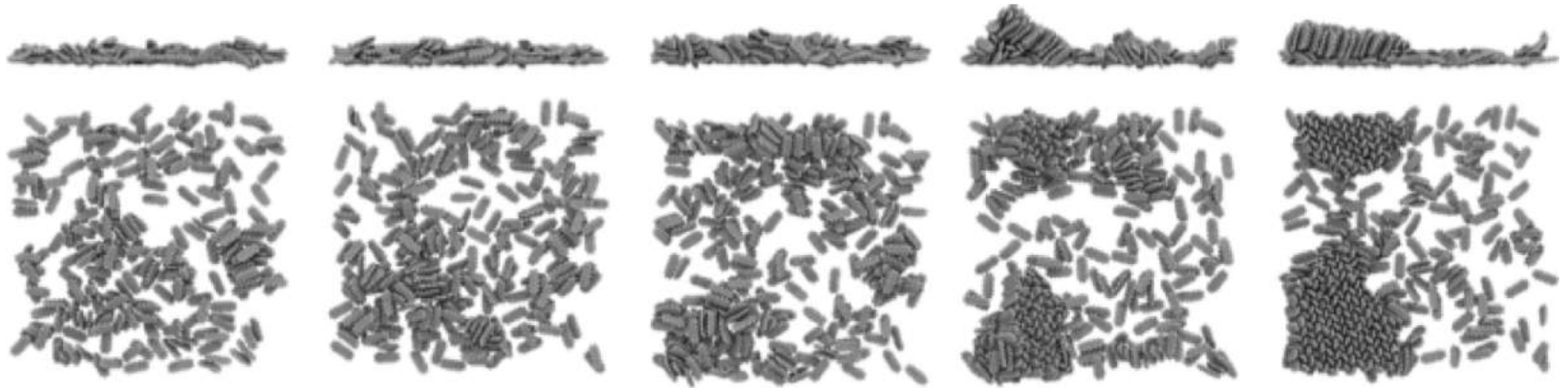

# Calculating Ehrlich-Schwoebel barrier

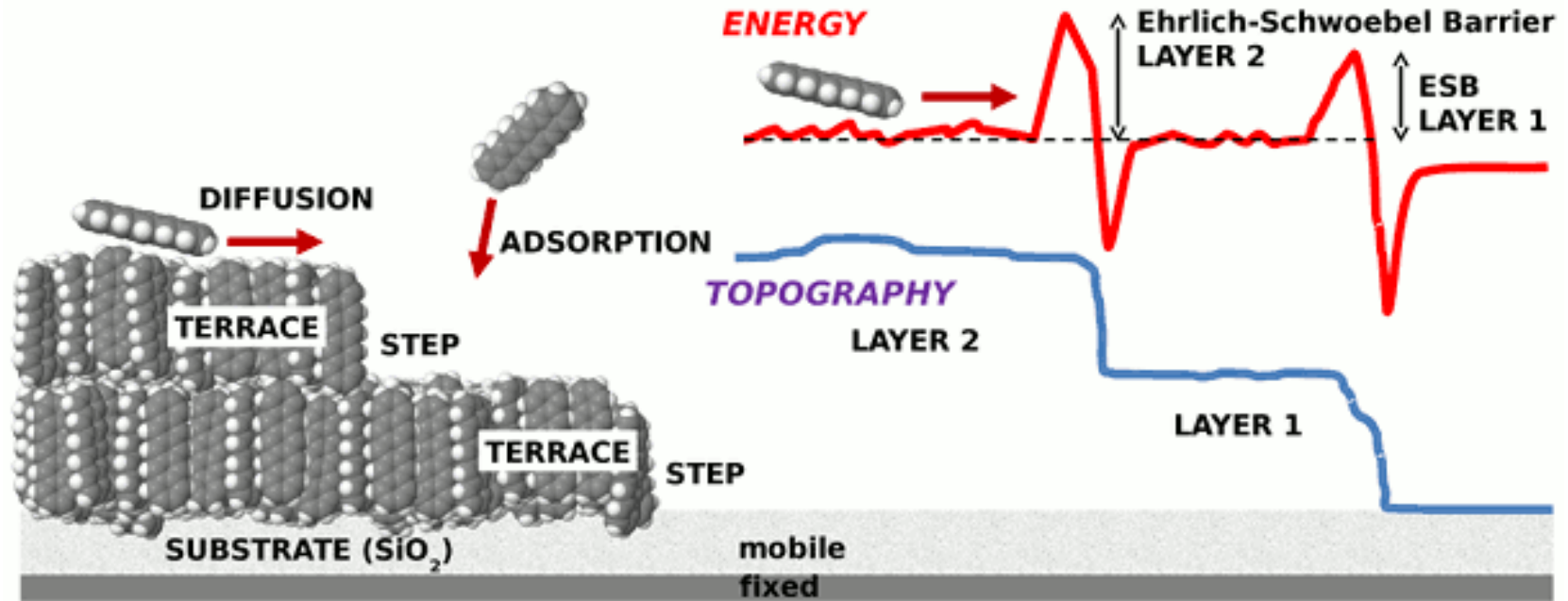

- when crossing a step edge a molecule passes through an area with a lower number of neighbours
- Ehrlich-Schwoebel barrier: energy required going to terrace  $n$  to  $n-1$  (downhill)
- very important parameter for growth

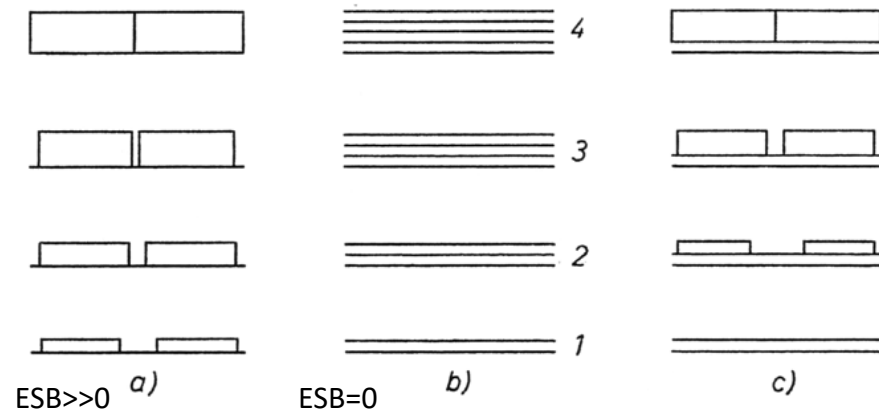

**Figure 3.** Schematic growth morphology for (a) Volmer–Weber, (b) Frank–van der Merwe, and (c) Stranski–Krastanov growth

# Ehrlich-Schwoebel barrier for pentacene on silica

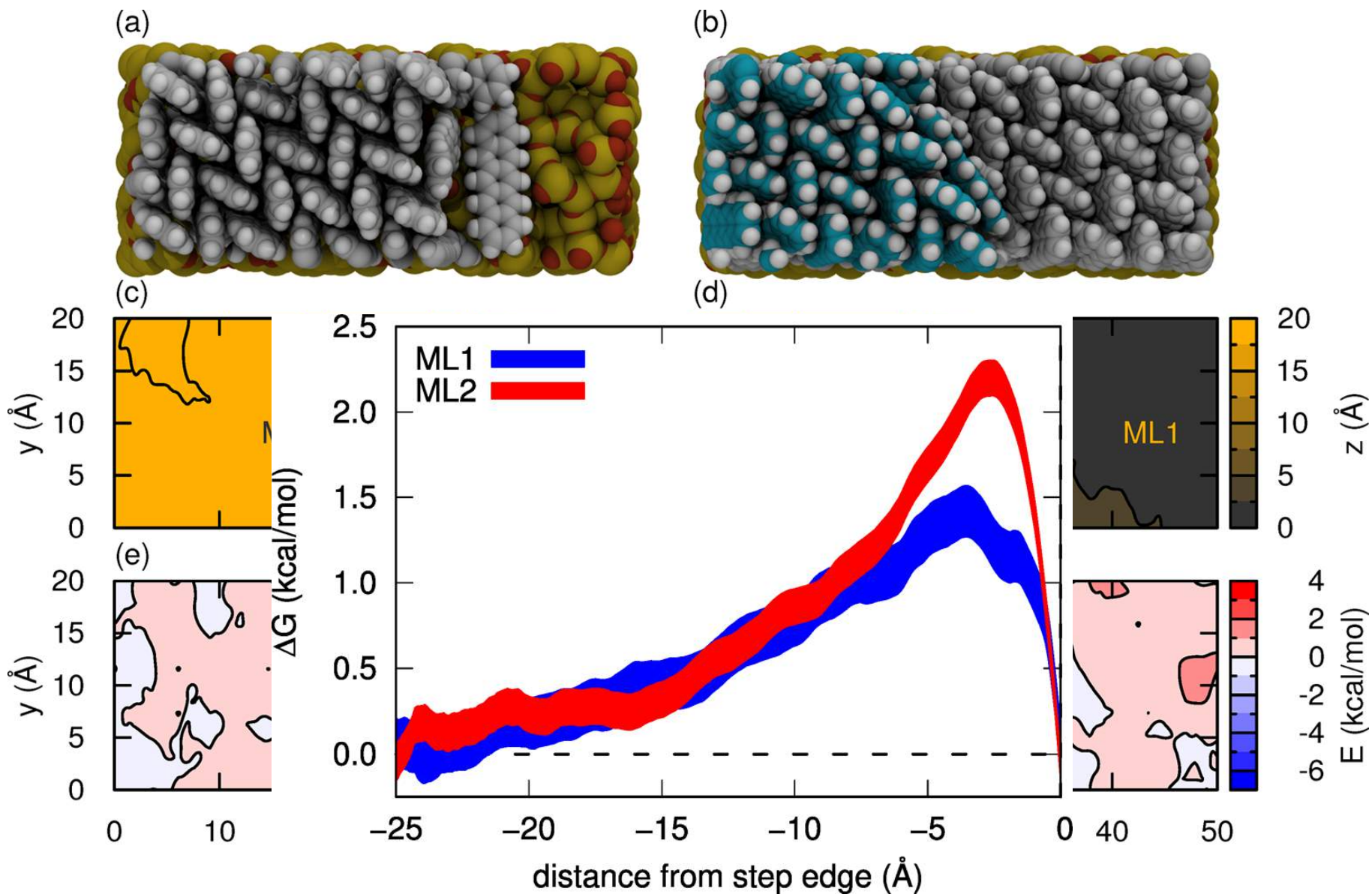

# Self-assembled monolayers

Efficient coatings for inorganic surfaces

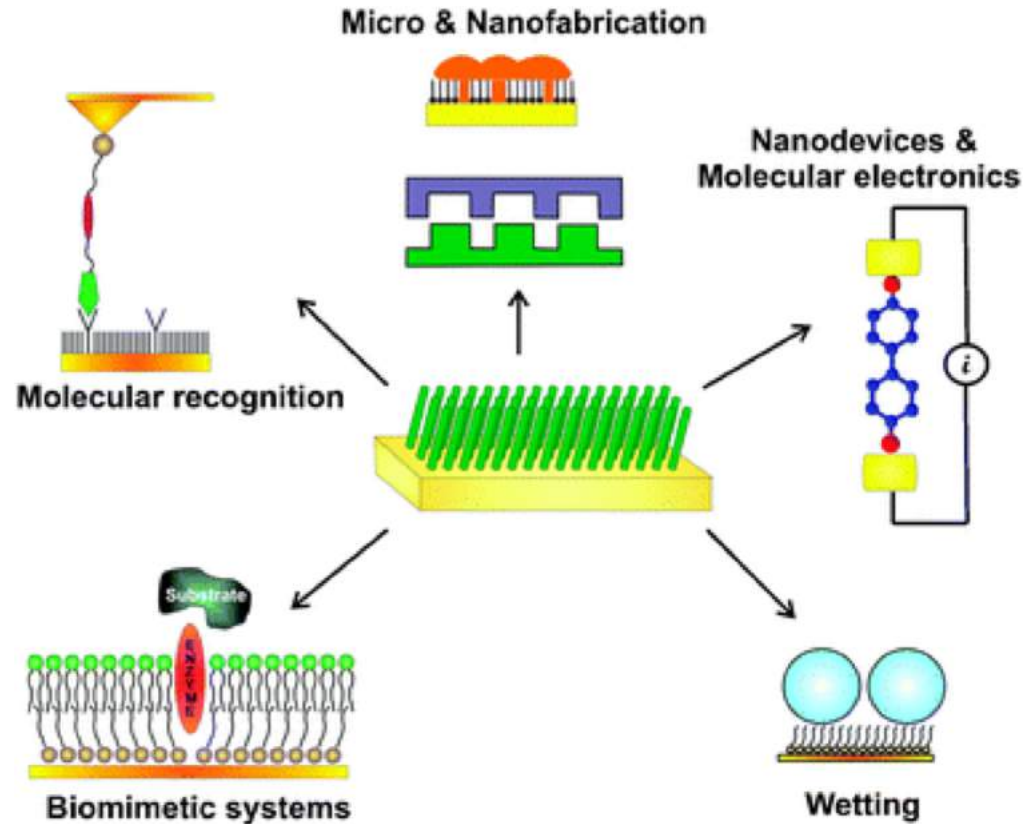
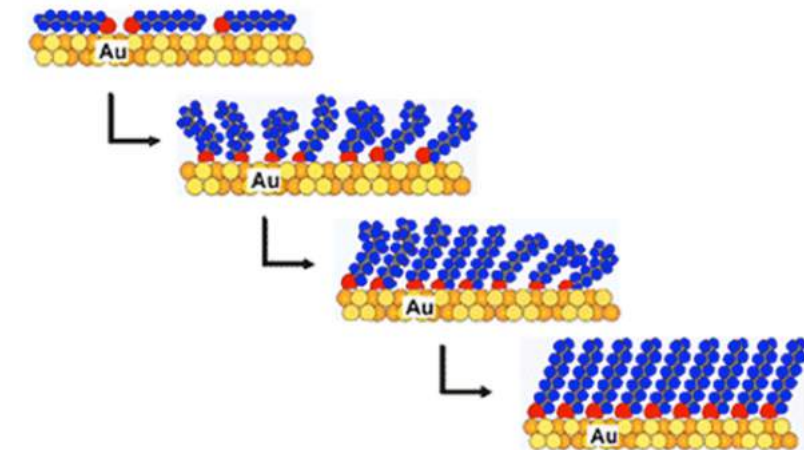
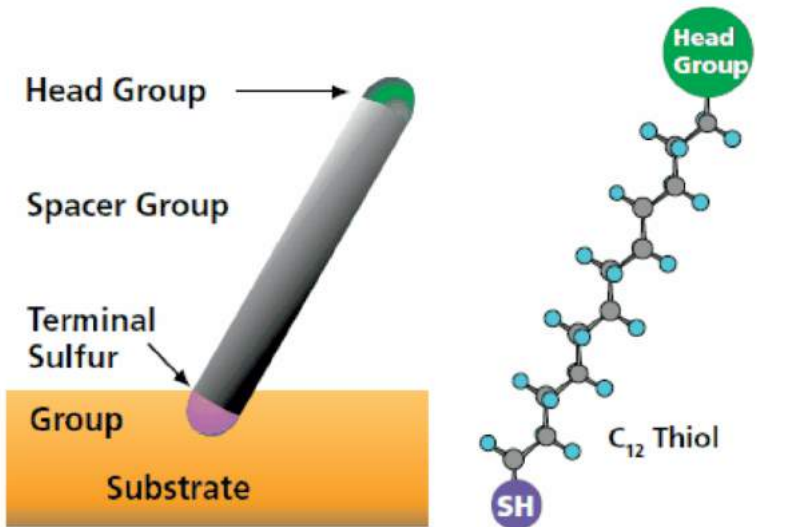

Critical parameter in self assembling is the coverage



# Simulations of “standard” SAMs on silica

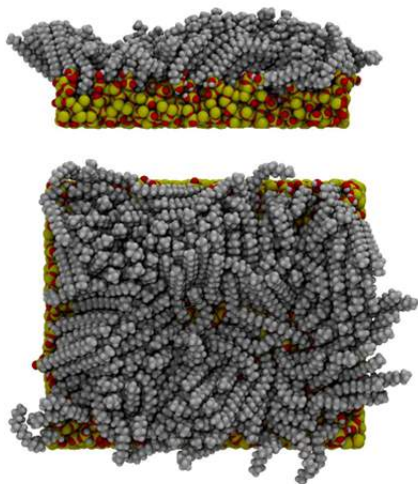

OTS: 2.5 molecules/nm<sup>2</sup>

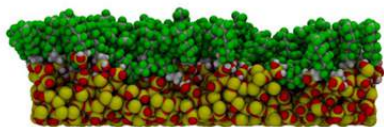

FDTS: 2.5 molecules/nm<sup>2</sup>

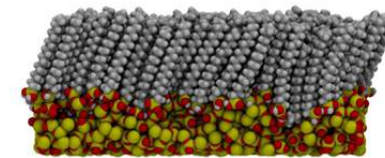

OTS: 4.5 molecules/nm<sup>2</sup>

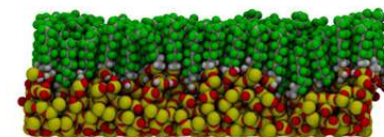

FDTS: 3.8 molecules/nm<sup>2</sup>

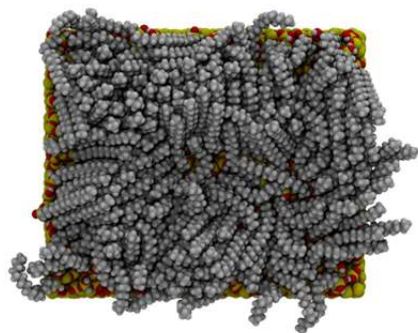

OTS: 2.5 molecules/nm<sup>2</sup>

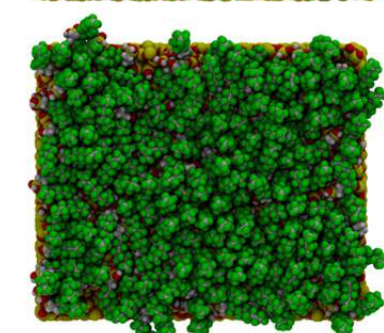

FDTS: 2.5 molecules/nm<sup>2</sup>

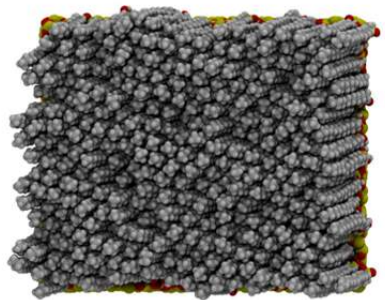

OTS: 4.5 molecules/nm<sup>2</sup>

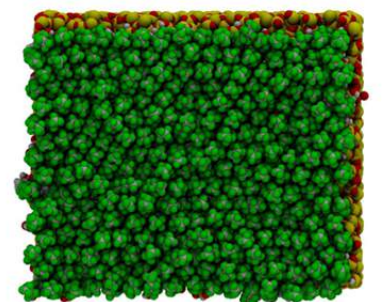

FDTS: 3.8 molecules/nm<sup>2</sup>

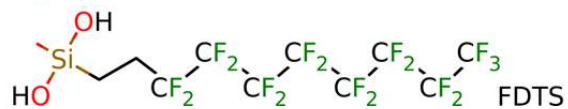
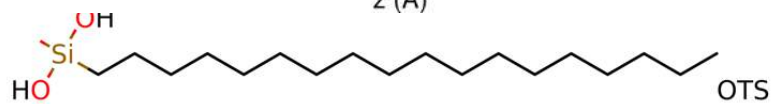
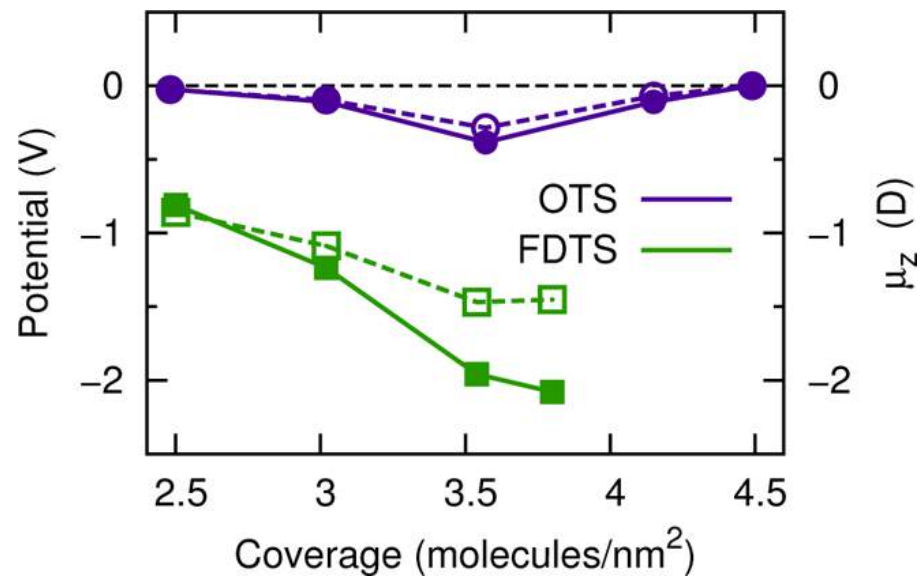
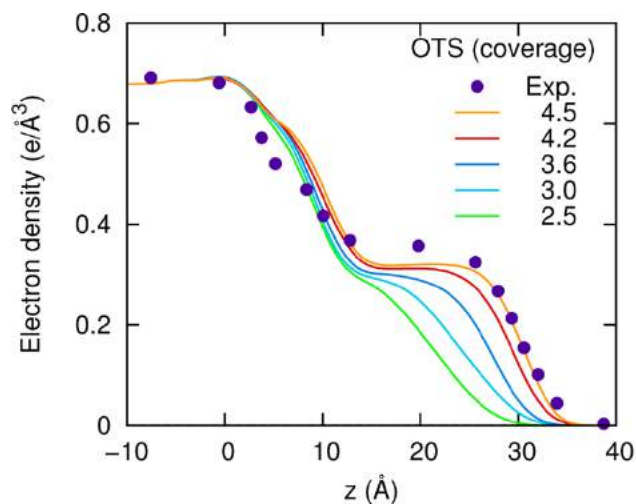

A. Mityashin *ACS Appl. Mater. Interfaces* 6:15372 (2014)

O. M. Roscioni *J. Phys. Chem. C* 120:14652 (2016)

# “Photo”switching a self-assembled monolayer

Prototype model for photoswitchable transistors and sensors

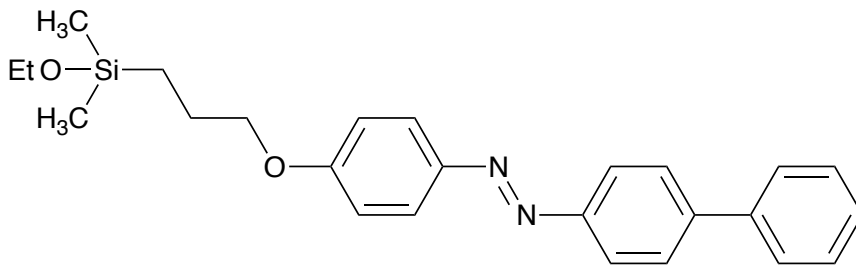
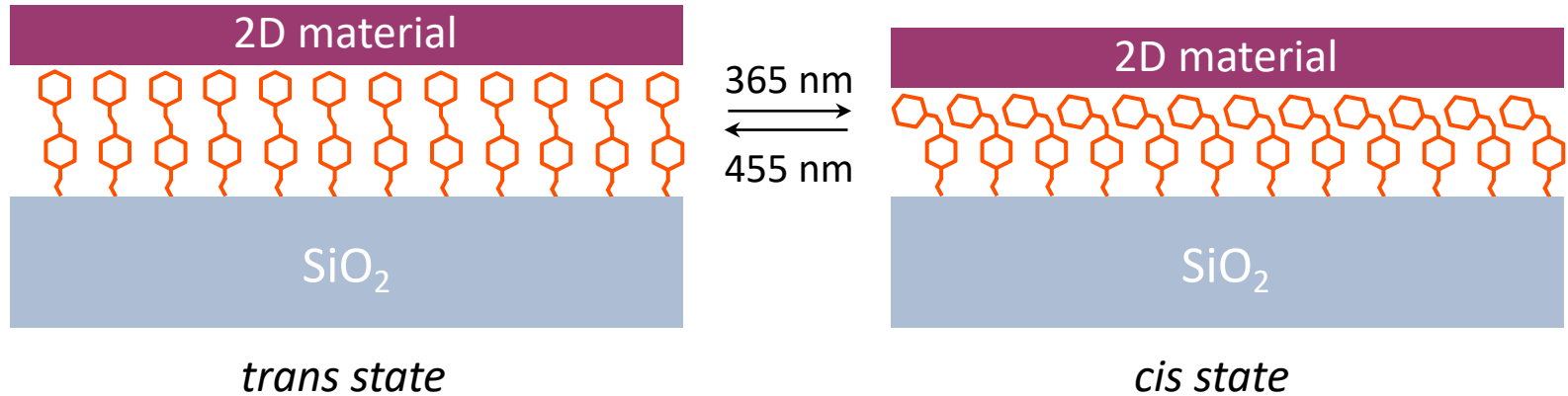

photoswitching is obtained by changing the torsional Potential of trans molecules

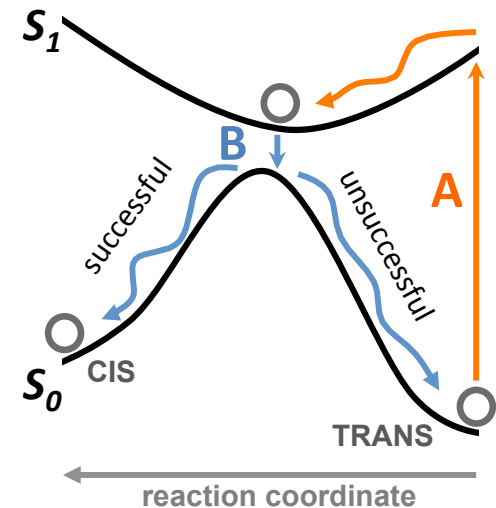

# Effect of coverage

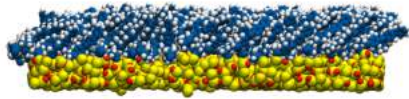

2.4 molecules/nm<sup>2</sup>

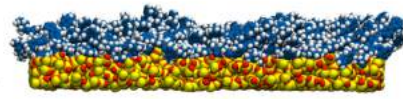

1.6 molecules/nm<sup>2</sup>

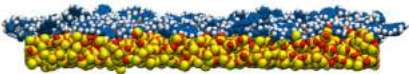
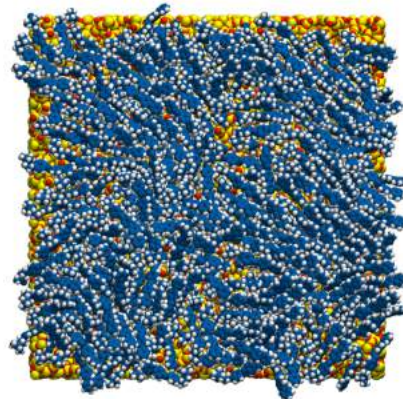
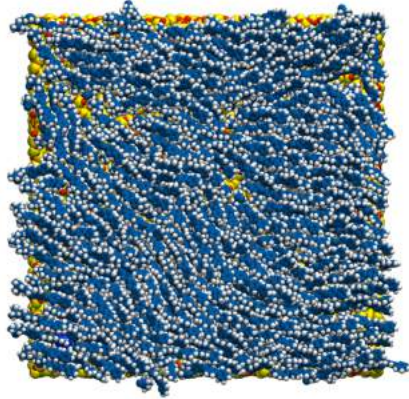

0.8 molecules/nm<sup>2</sup>

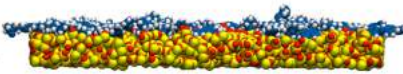

0.3 molecules/nm<sup>2</sup>

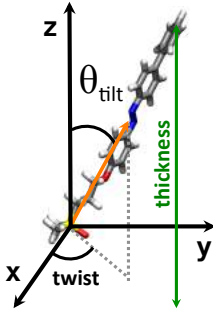
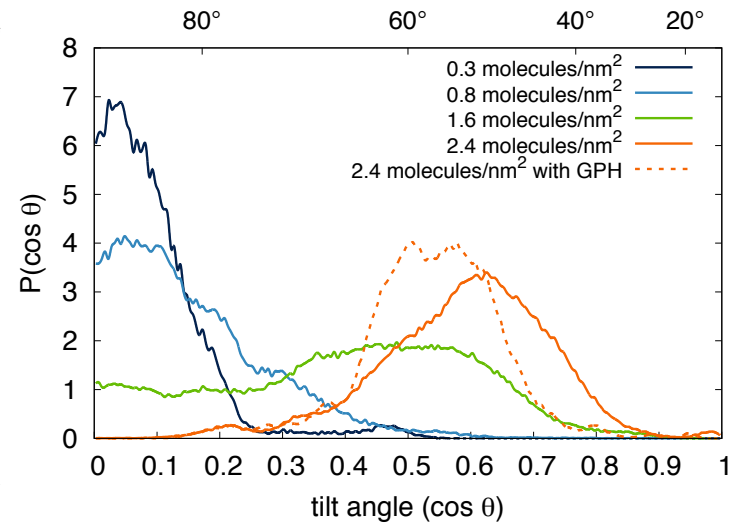
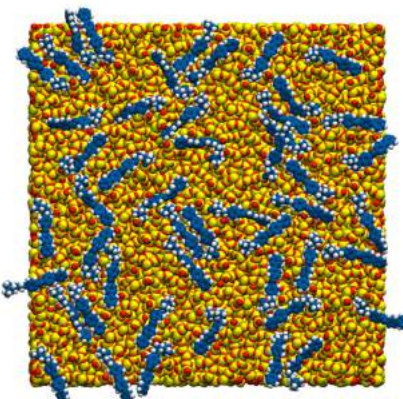
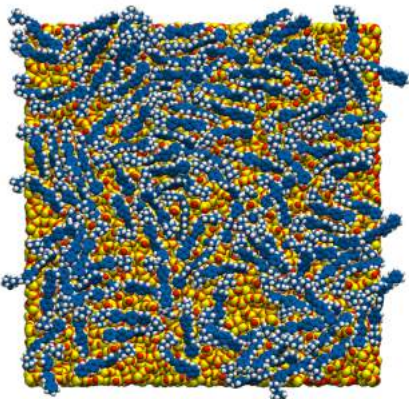

FOR INCREASING COVERAGE

THICKNESS

TILT

ORDER



# Effects of switching

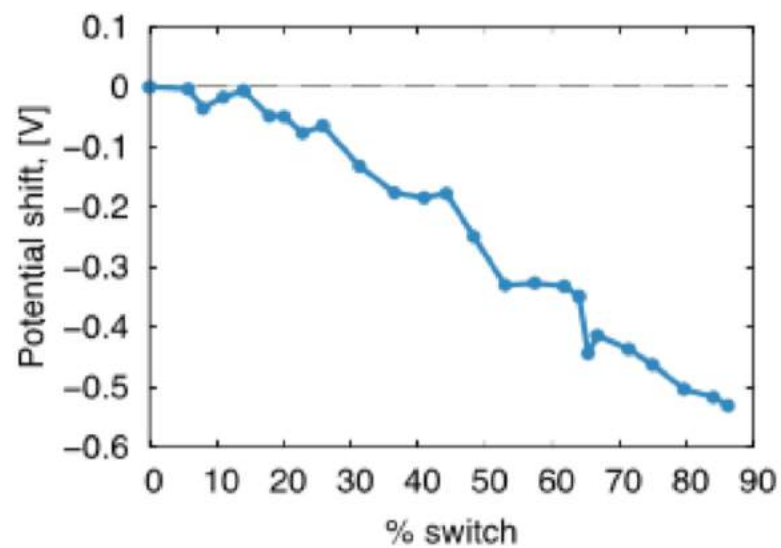
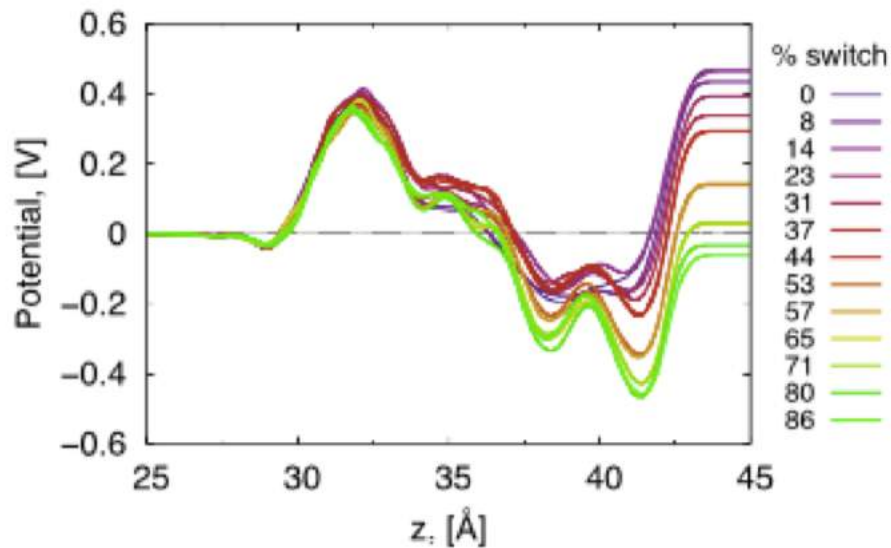
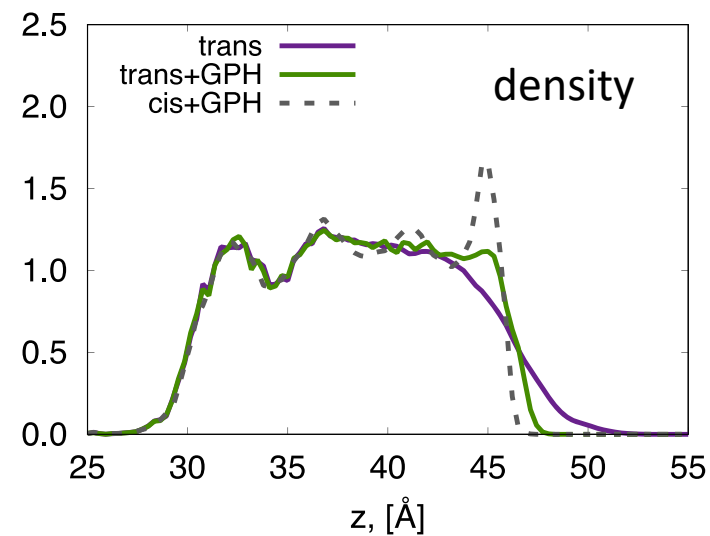
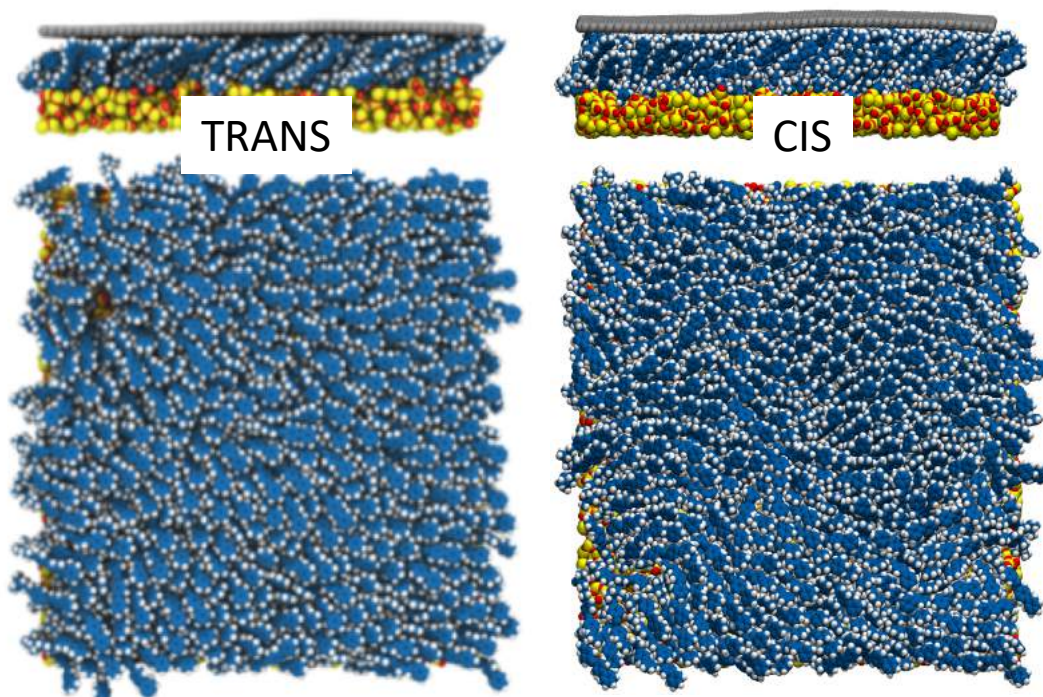



# Electrostatic potential maps

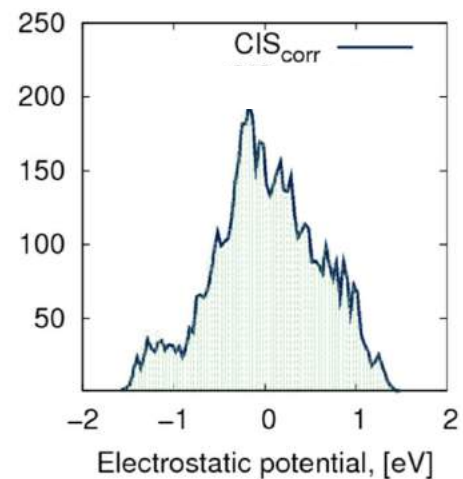
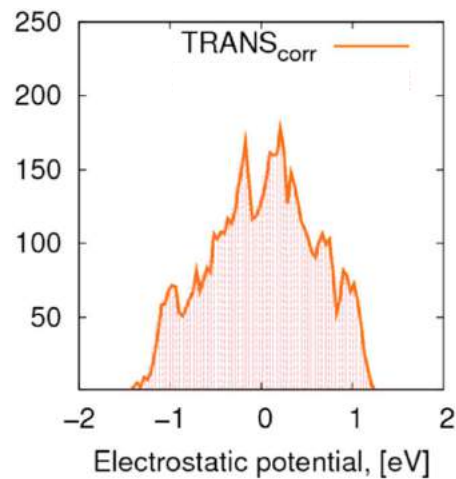
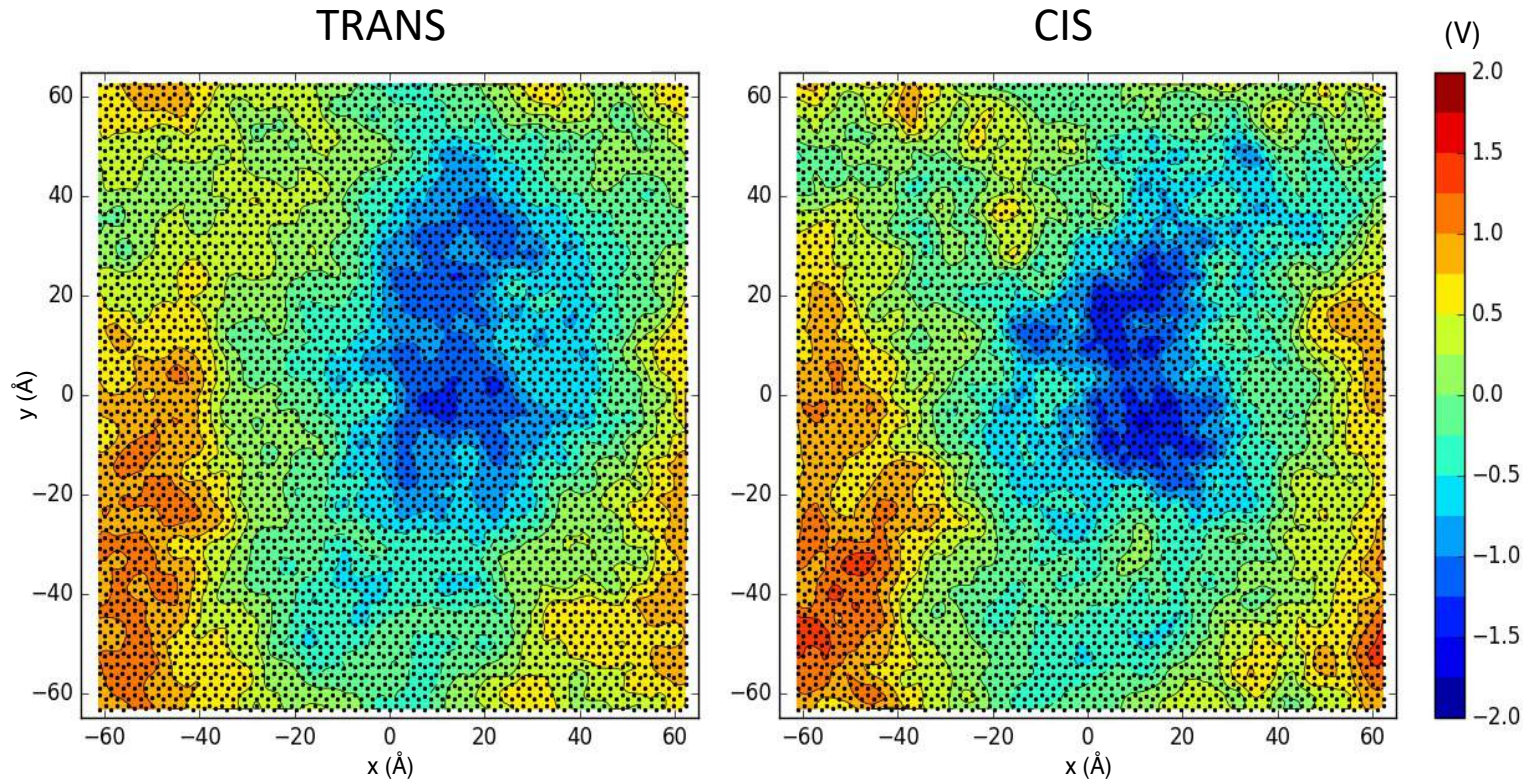

# Effects on graphene conductivity

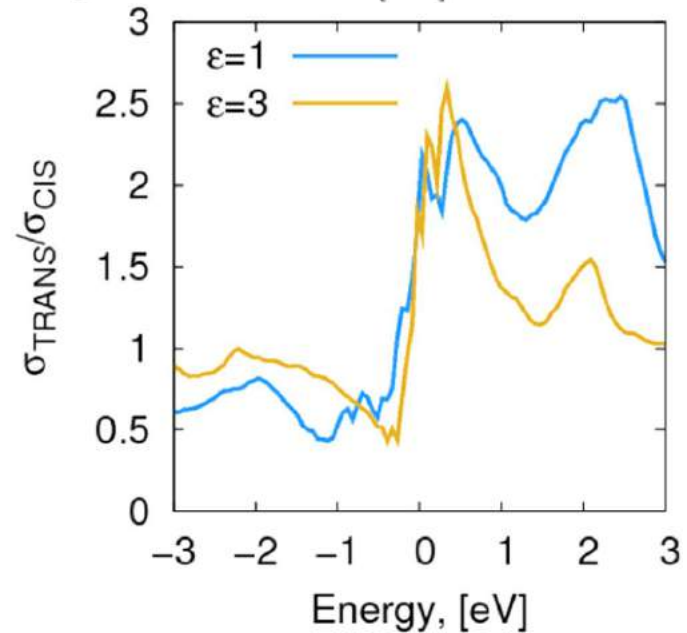
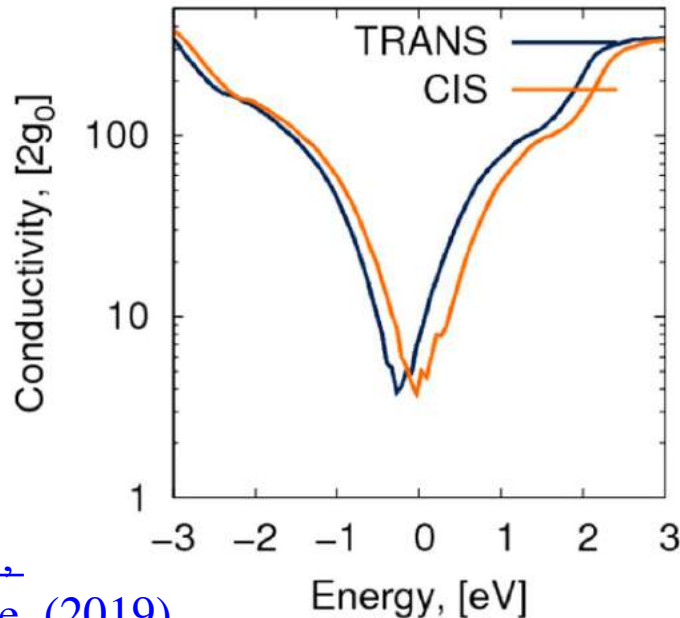
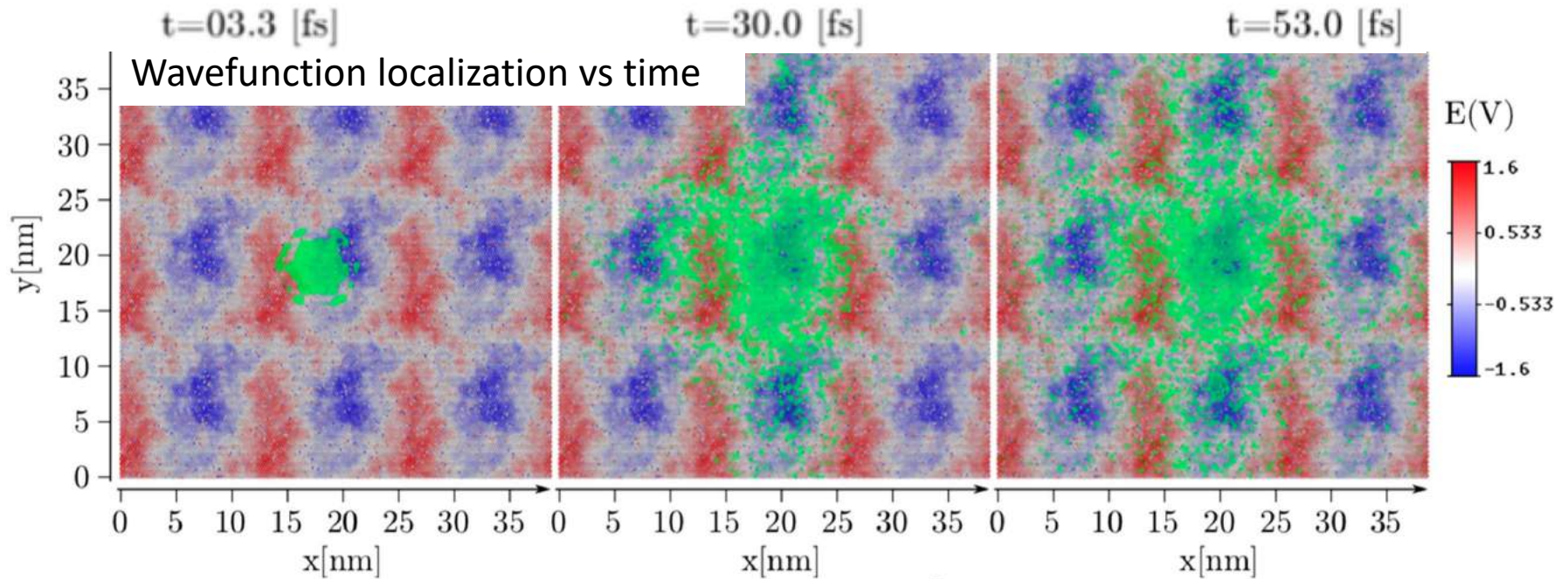

# Conclusions

Applications of MD/MC simulations to organic (electronics) materials can provide information at the nanoscale and complement experimental measurements

Skills required:

- a bit of knowledge of physical chemistry
- tuning of model & size, choice of parameters
- no fear of programming / scripting

Future:

- development of multiscale methods
- more accurate intermolecular forces
- computational material screening (“machine learning”)
- increasing number of industry jobs