

Academic Skills

How to Write a Scientific Paper

Maxim S. Pshenichnikov



University of Groningen
Zernike Institute
for Advanced Materials

Preface

What is the 100% hit-the-target strategy of good scientific writing?

IT DOES NOT EXIST !!!

Why should we continue?

I still hope that what I just said is not entirely true. In any case, I would like to try.

ALL Instruction Texts have an identical goal:

to communicate your idea to others

- What do you want to tell? (too little vs. too much)
- Whom do you want to tell to? (your audience)

But this is not enough!

You have to:

- logically order what you want to tell
- write down what you want to tell
- re-write what you have written
- re-re-write what you have re-written of what you had written
- work out ALL technical details
- and many other things

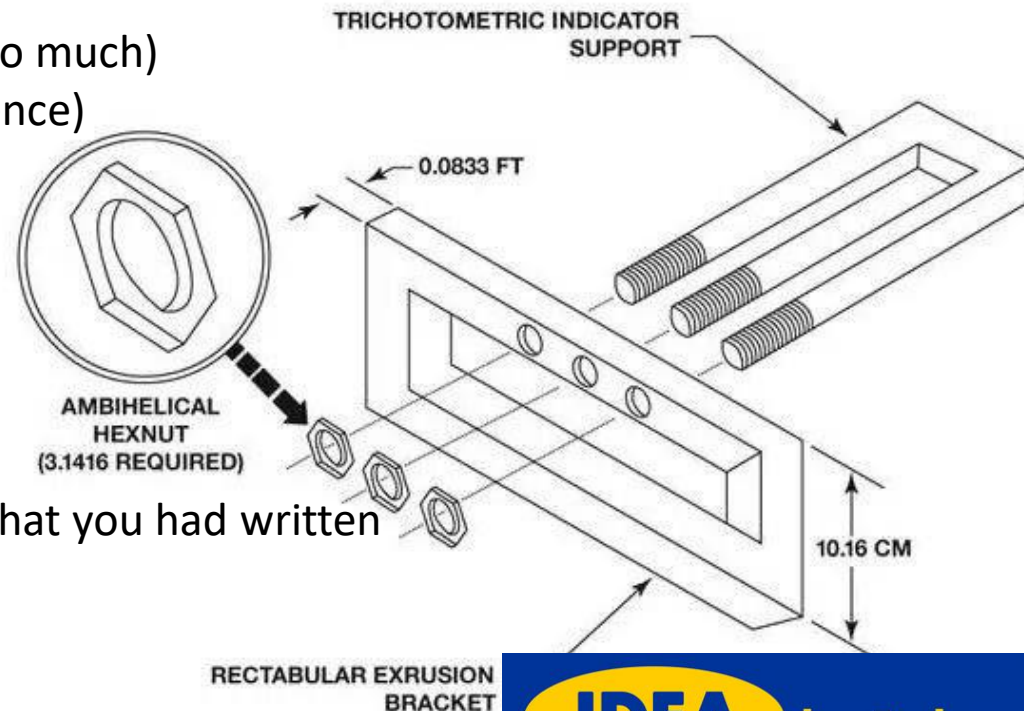

What This Lecture Is All About

The lecture is intended to provide

- *general* content
- style
- format guidelines

for scientific paper writing

The format can be easily adapted to interim reports, bachelor, master and PhD thesis

This lecture is a *necessary* tool of learning the scientific writing style

But!

It is not *sufficient*, by itself, to make you an accomplished writer

You, the writer, must practice *writing* and *thinking* within this structure learnt by example

Improvements in your writing skills will come by

- reading
- writing
- critiquing of other's writing

Pay attention to how professional scientists write about their work!

NB: This lecture will not teach you how to write in the English language (not a grammar book)

Lecture Content

(1) Fundamental style considerations

- what is scientific writing?
- what is a scientific paper?

(2) Scientific paper organization: IMRAD(C)

- suggested strategies for efficiently writing up every section
- the nuts and bolts of format and content of each section of a paper

(3) Practical paper writing

- sequence of paper writing
- design of figures
- paper improvements
- check-list “before submitting”

(4) Scientific paper cycle

- where to submit
- responding to reviewers’ comments
- English as a foreign language

(5) Conclusions



What Is Scientific Writing ?

- reporting original research in journals, through a scientific paper in standard format
- communication about science in review articles
- other types of professional communications (grant proposals, oral presentations, posters ...)

Need of clarity:

- clearly stated problem
- clearly stated conclusion
- new knowledge “for the first time”
- not literature nor poetry

Receiving the signals:

Scientific communication is a two step process:

Need to be conveyed – need to be understood

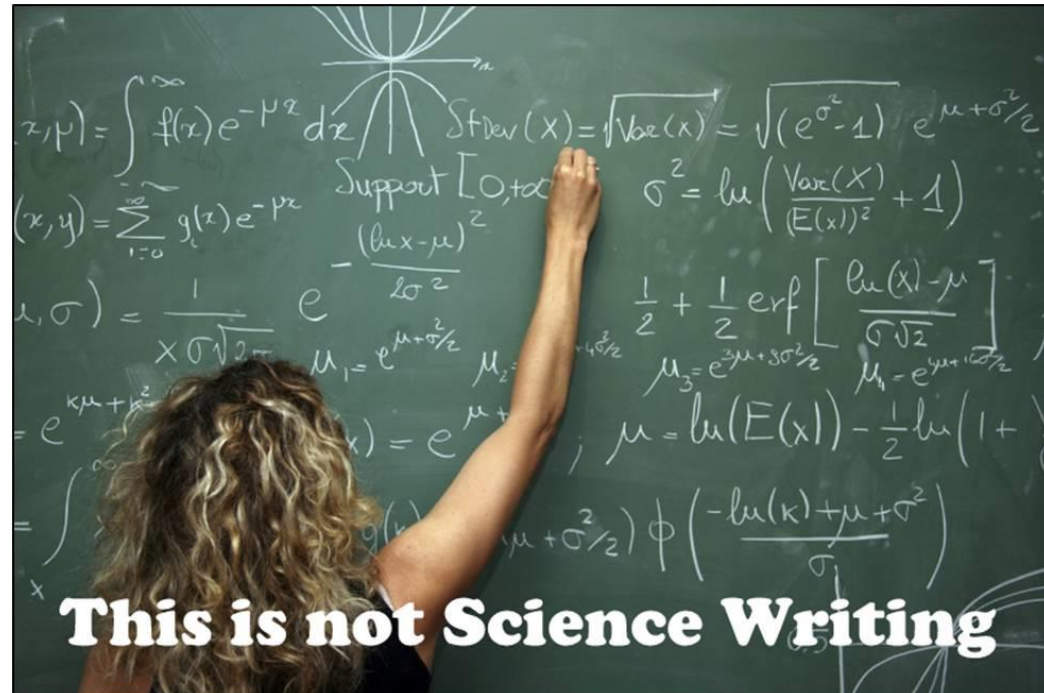

Publication = ultimate result of scientific research \Rightarrow same effort as for the rest

Best English = same content in the fewest short words (no diversion, metaphors,)

Goal of publications

to **report new results** in scientific journals in order to **disseminate** information to the larger community of scientists

Scientists are measured and become known (or unknown) by their publications

“What is unpublished, has never happened”

How and when does a young scientist learn how to write?

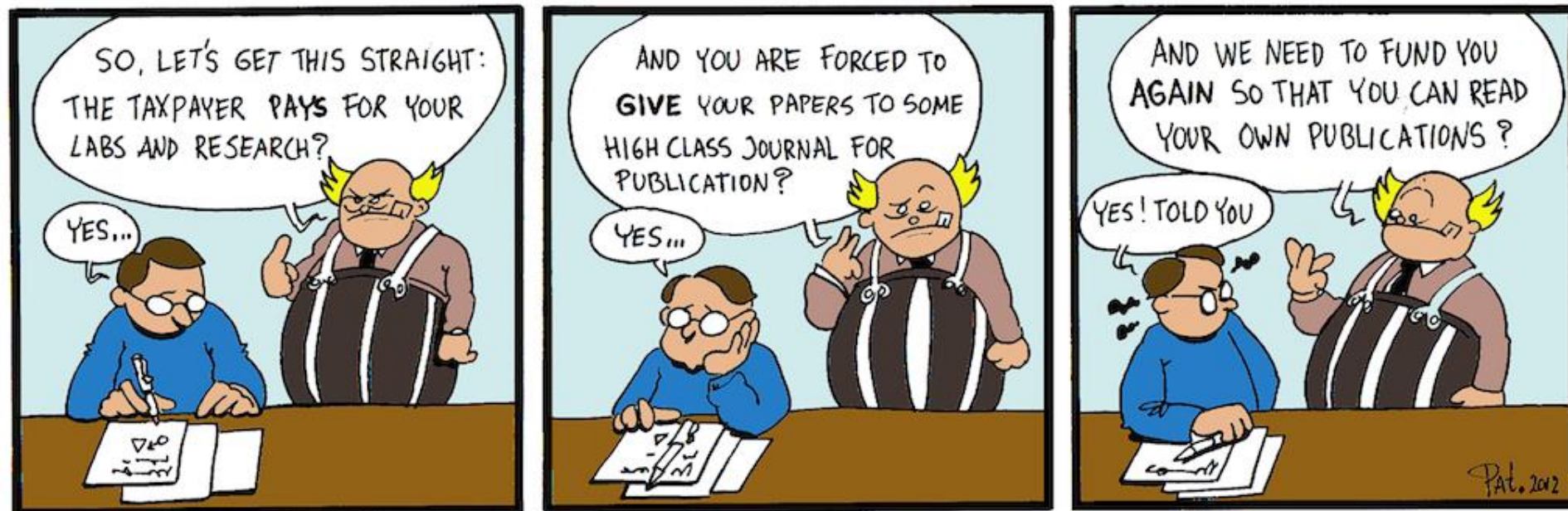

What Is a Scientific Paper?

- **written** (in a certain way as defined by tradition, editorial practice, scientific ethics) and
- **published** report describing original research results

An acceptable **primary scientific publication** must be the **first disclosure** containing sufficient information to enable peers

- to assess observation
- to repeat experiments
- to evaluate intellectual processes (i.e. conclusion justified by the data)

Scientific papers must be **published in the right place** i.e. primary journals (not reports, conference proceedings ...)



Paper Organization: IMRAD(C)

Introduction

Materials and Methods

Results

and

Discussion

Conclusions

Supplementary Materials



A scientific paper is **NOT** literature BUT **communication** of research results!

Scientific writing requires special attention to **order** and **organization**

"fuzzy writing reflects fuzzy thinking"

How to Entitle the Manuscript

Function: the Title describes the contents of the paper

- Importance: read by thousand of people (only few if any will read the full paper)
- **Suggested rules:**
 - Needs to reach its intended audience
 - Title = Label suitable for indexing
 - Syntax: careful choice and order of words
- **Tips:**
 - Fewest possible words that adequately describe the content of the paper
 - Not too short: need for specific title (no general)
 - Not too long: not an abstract
 - No waste words (study on ..., observations on ..., verb)
 - No abbreviations, jargon, ...
 - Avoid series titles each paper

How to Entitle the Manuscript: Examples

“Highly-Emissive Solution-Grown Furan/Phenylene Co-Oligomer Single Crystals”

vs.

“Novel Organic Crystals: Shine as a Crazy Diamond ”

“Rapid and reversible absorption of water in methyl-ammonium lead iodide perovskite under ambient conditions ”

vs.

“Water Infiltration in Methylammonium Lead Iodide Perovskite: Fast and Inconspicuous ”

Function: to list those who participated in the research

- Authorship?
 - Takes the intellectual responsibility of the results being presented
 - Should have made an important contribution to the study being reported (referring to original aspects)
 - Intellectual input: not easy to measure
- **Suggested rules:**
 - Order of names? -> Origin of endless disputes and arguments
 - More than one initial recommended
 - Keep your name identical through your scientific career!
- **Tips:**
 - Corresponding author (reprints address, proofs, ...)
 - Be ready to specify contributions (who did what)

How to List the Authors: Example

PRL **116**, 057402 (2016)

PHYSICAL REVIEW LETTERS

week ending
5 FEBRUARY 2016

Real-Time Tracking of Singlet Exciton Diffusion in Organic Semiconductors

Oleg V. Kozlov,^{1,2} Foppe de Haan,¹ Ross A. Kerner,³ Barry P. Rand,³ David Cheyns,⁴ and Maxim S. Pshenichnikov^{1,*}

¹Zernike Institute for Advanced Materials, University of Groningen, 9747AG Groningen, The Netherlands

²Faculty of Physics and International Laser Center, Lomonosov Moscow State University, Leninskie Gory 1, 119991 Moscow, Russia

³Department of Electrical Engineering and Andlinger Center for Energy and the Environment,
Princeton University, Princeton, New Jersey 08544, USA

⁴IMEC, Kapeldreef 75, B-3001 Leuven, Belgium

Oleg led the project

Ross performed
x-ray characterization

David made the
samples

Foppe is a software
technician but his
contribution to
modelling was
instrumental

Barry inspired the
project

Maxim developed
and supervised the
project

How to List the Authors: Example



ELSEVIER

Physica B 294–295 (2001) 736–739



PHYSICA B

www.elsevier.com/locate/physb

Detection of earth rotation with a diamagnetically levitating gyroscope

A.K. Geim^{*}, H.A.M.S. ter Tisha

High Field Magnet Laboratory, University of Nijmegen, Toernooiveld 1, 6525 ED Nijmegen, The Netherlands

H.A.M.S. ter Tisha contributed to the levitation experiment “most directly”

Later H.A.M.S. ter Tisha applied for a PhD at the Radboud University Nijmegen, Netherlands but his application was turned down

How to Write the Abstract

Function: An abstract summarizes the major aspects of the entire paper

- Abstract = a miniature version of the paper (~150-250 words)
- Allows the reader to decide to read or not
- **Suggested rules** -- IMRAD(C) structure :
 - State the problem at large
 - State principal objectives and scope
 - Describe the methodology employed
 - Summarize the key quantitative results, or trends
 - State the principal conclusions
(YES: conclusions are listed 3 times -- in Abstract, Introduction and Conclusions)
 - Clearly state the implications of the answers your results gave you
- **Tips:**
 - No references
 - Self contained (published by itself)
 - Economy of words (but no abbreviations)
 - Past tense because refers to work done

How to Write the Abstract: Example

(General background)

Scientists must write to succeed, but few receive training in scientific writing.

(Goal)

We studied the effect of a scientific writing lecture series on publication performance.

(Method)

During the SEPOMO workshop, 20 PhD students attended a 2-hours lecture on the topic while the control group did not attend the lecture (nor the Workshop). The publication output of each group was monitored for 4 further years.

(Results)

The control-group members on average submitted 6.1 papers to journals and had 4.1 accepted. The corresponding figures for the lecture group were 8.3 and 7.7.

(Conclusions)

These findings suggest that instruction in scientific writing increases knowledge of scientific communication and promotes publication success.

How to Write the Introduction

Function: Establish the context of the work being reported

- From problem to solution (even if some redundancy with Abstract)
- Justify why you chose that subject and why it is important
- State briefly and clearly your purpose
- **Suggested rules:**
 - Present first the nature and scope of the work
 - Review the literature (most important background information)
 - State the problem that the paper solves
 - State the methods of investigation, so as the reasons for their choice
 - State the principal results
 - State the principal conclusions suggested by the results
- **Tips:**
 - Decide the audience
 - Why did you choose this kind of experiment or experimental design?
 - Avoid mistake: do not keep the reader in suspense (not a detective story)
 - List the merits of the new technique/method versus the previously used methods
 - Present tense for the established knowledge

How to Write the Introduction: Example

Highly Luminescent Solution-Grown Thiophene-Phenylene Co-Oligomer Single Crystals

Lyudmila G. Kudryashova,[†] Maxim S. Kazantsev,^{‡,§} Valery A. Postnikov,^{||} Vladimir V. Bruevich,[†] Yuriy N. Luponosov,[⊥] Nikolay M. Surin,[⊥] Oleg V. Borshchev,[⊥] Sergei A. Ponomarenko,^{⊥,#} Maxim S. Pshenichnikov,[§] and Dmitry Yu. Paraschuk^{*,†}

The nature and scope of the work

Thiophene-phenylene co-oligomers (TPCOs) are among the most promising materials for organic light-emitting devices as their single crystals combine efficient charge transport and luminescence.¹⁻⁴ The photoluminescence (PL) external quantum yield (QY) of up to 38% was reported for vapor-grown TPCO single crystals^{5,6} with 100% internal PL QY suggested.⁷ Such remarkable electronic properties of TPCO single crystals together with their high thermal stability and high quality surfaces make them attractive candidates for electrically pumped organic lasers.⁸⁻¹⁰ **Literature review**

Typically, the highest performance is reported for organic semiconducting crystals grown from the vapor phase using physical vapor transport (PVT) technique.¹ On the other hand, thin single-crystalline TPCO films can also be grown using solution methods,¹¹⁻¹³ which are preferential for practical applications. Recently, monoexponential PL kinetics in the broad dynamic range have been reported for solution-grown TPCO crystals, which signifies their low-defect electronic structure.¹³ Furthermore, TPCO single crystals grown at the gas-solution interface demonstrate a molecularly smooth

surface,¹³ which is indispensable for high performance organic field-effect transistors (OFETs). All these facts inspire further investigation of the solution-grown TPCO crystals for their optical and charge transport properties. **Motivation**

Here we report on record high PL QY among TPCO single crystals reaching 60%, which is higher for the solution-grown crystals than for the vapor-grown ones. We show that packing of TPCOs in an ordered crystal structure does not hinder but increases the PL QY by a factor of 3, most probably due to suppression of the radiationless relaxation channel. Furthermore, the solution-grown TPCO single crystals perform in OFETs as good as the vapor-grown ones. All in all, the solution-grown semiconducting TPCO crystals are demonstrated to hold great potential for organic electronics.

Received: December 8, 2015

Accepted: January 19, 2016

the principal results

the principal conclusions

the problem that the paper solves

How to Write the Materials and Methods Section

Function: Describe and justify the experimental design so that the experiments could be repeated by others (peers)

- Protocols for collecting and analyzing the experimental data
- Must give the full details (if not \Rightarrow rejection by the referee no matter the results)
- **Important rule:**
 - enough information must be given so that the experiments could be reproduced by a competent colleague*
 - Reproducibility = basis of Science
 - Your reputation is damaged if results are not reproducible
- **Suggested rules:**
 - Similar to cookbook recipes: - How? - How much?
- **Tips:**
 - Avoid mistake : No mixing with some of the results
 - The reader should understand the logical flow of the experiment(s)
 - Use sub-headings
 - Use past tense

How to Write the Results

Function: To objectively present your key results in a logical sequence to support (or provide evidence against) the hypothesis, or answer the question, stated in the Introduction

- Result section = Core of the paper
- Strive for crystal clarity: the whole paper will stand or fall on the basis of the results
- **Suggested rules:**
 - Predigested oresentation of the data: only representative data, not all
"The fool collects facts, the wise selects them"
- **Tips:**
 - Avoid redundancy: repetition in the text of what is apparent in Figures or Tables
 - No need to cite Figures and Tables as "It is clearly shown in Figure X that..."
 - Not yet data interpretation: the discussion section follows later (?)
 - Past tense

How to Write the Discussion

Function: to interpret your results in light of what was already known about the subject of the investigation, and to explain our new understanding of the problem after taking your results into consideration.

- Harder part to define and to write ← Cause of rejection
- Show logical relationships among observed facts
- **Suggested rules:**
 - Format: inverted funnel
 - Present the principles, relationships, generalization shown by the results, but not a recapitulation of the results
 - Show how your results and interpretations agree (or contrast) with previously published work
 - Discuss the potential implications of your work especially practical applications
 - Don't be fearful or hesitant
- **Tips:**
 - Be modest: Scientific truth \neq whole truth; it's only a spotlight shining on one particular area
 - Don't extrapolate to a bigger picture than that proven by your data

How to Write the Conclusions

Function: short summary regarding your results and the significance of the work

- **Suggested rules:**

- State your conclusions as clear as possible
- Summarize your evidence for each conclusion

- **Tips:**

- Do your findings agree with what others have shown? If not, do they suggest an alternative explanation or perhaps a unforeseen design flaw in your experiment (or theirs?)
- Given your conclusions, what is our new understanding of the problem you investigated and outlined in the Introduction?
- If warranted, what would be the next step in your study, e.g., what experiments would you do next?

Bad, if the reader at end asks "So what?"

And yes, this is the 3rd time you list your main findings!

Real-Time Tracking of Singlet Exciton Diffusion in Organic Semiconductors

Oleg V. Kozlov,^{1,2} Foppe de Haan,¹ Ross A. Kerner,³ Barry P. Rand,³ David Cheyns,⁴ and Maxim S. Pshenichnikov^{1,*}

Main conclusion

In summary, we have demonstrated efficient exciton harvesting from vacuum-deposited C₇₀ layers up to 70 nm thick with the unique time-of-flight spectroscopic approach that allows us to obtain the diffusion coefficient and exciton harvesting distances from a single sample. The experimental data are perfectly described by a simple analytical model, allowing us to obtain the diffusion rate of $D \approx 3.5 \times 10^{-3} \text{ cm}^2/\text{s}$ from a single sample. We foresee the proposed noninvasive time-of-flight technique as a powerful tool for further development of organic optoelectronic components, such as simple layered solar cells [44], thin-film light-emitting transistors, and electrically pumped lasers.

Important findings

Further applications

How to write the Acknowledgments

Function: to thank people outside the authors' list for their assistance and the service or material or funds provided

- **Suggested rules: acknowledge**

- Technical help
- Advisors, ... (be specific, they are not responsible for the work)
- Financial assistance (grants, fellowships, contracts, ...)

- **Tips:**

- Be courteous
- *We thank ... NOT We wish to thank*
- Obtain permission for being acknowledged
- Be specific about the contribution
- Don't forget funding agencies
- Be brief

How to write the Acknowledgments: Example

Acknowledgements

The authors thank Vlad Pavelyev for valuable contribution to the experimental work at early stages, Almis Serbenta for measuring the 3–11 μm polaron spectra, Artur Mannanov for assistance in measuring 1T:PC₆₁BM dynamics, and Paul van Loosdrecht for many fruitful discussions. O.V.K. acknowledges support by “Aurora—Towards Modern and Innovative Higher Education” Programme, and by Russian Foundation for Basic Research, research project No. 14-02-31632. Y.N.L., S.A.P., and D.Y.P. thank Russian Science Foundation (grant 14–13–01380) for financial support. D.Y.P. acknowledges partial support from M. V. Lomonosov Moscow State University Program of Development.

“Thanks are due to Jones for assistance with experiments and Smith for valuable discussions”

Jones did most of the experiments

Smith provided interpretations for Jones’ experiments

“We thank the Director of the Wetson Institute, Prof. Bakker for not interfering with our research and letting us go our way”

References

Function: a listing of the references that you actually cited in the body of your paper, in the format required by the journal

- **Suggested rules:**

- Avoid secondary materials (only significant, published references)
- Place citation at the point of the sentence it applies (not always at the end of sentences)

- **Tips:**

- Make sure that ALL parts of the reference are accurate
- Be aware of hundreds of reference styles!
- Read carefully “the instruction to authors” of the journal
- Use citation management software
- Do not list references that you may have read but have not specifically cited

References: Example

Macromolecules 2015, 48, 2013–2021

(24) Cardona, C. M.; Li, W.; Kaifer, A. E.; Stockdale, D.; Bazan, G. C. *Adv. Mater.* **2011**, 23, 2367.

NATURE PHOTONICS | VOL 6 | AUGUST 2012 |

4. Van der Ende, B. M., Aarts, L. & Meijerink, A. Lanthanide ions as spectral converters for solar cells. *Phys. Chem. Chem. Phys.* **11**, 11081–11095 (2009).

PRL **116**, 057402 (2016)

[7] O. V. Mikhnenko, R. Ruitter, P. W. M. Blom, and M. Antonietta Loi, *Phys. Rev. Lett.* **108**, 137401 (2012).

Incorrect

M. Pchenitchnikov, How to read scientific papier, IJR, 2017

Correct

M.S. Pshenichnikov, How to write a scientific paper, International Journal of Rubbish 1, 666 (2017)

How to write Supplementary Materials

Function: to present information that is non-essential to understanding of the paper but further clarifies a point without burdening the body of the presentation.

- **Suggested rules:**

- Carefully dissect figures/derivations/tables of those without which you cannot convey the message (the main text), and those which role is important but secondary (supplementary materials)
- Style of supplementary materials – free but scientific nevertheless
- Remember that SM will be read by reviewers/real experts

- **Tips:**

- Complete datasets
- Blank experiments
- Chemical synthesis/characterization
- Do not be prudent in SM!

Volumes of the main text and supplementary materials

PRL: 4 ½ pages of the main text → 14 pages of SM

NatPhot: 4 ½ pages of the main text → 21 pages of SM

Sequence of Paper Writing: I

- **Get Organized: Lists, Outlines, Notecards etc**

- Develop a list of points to be made in the paper
- As you progress, begin to organize those points into sections

- **Make a Balanced Review of the Primary Research Literature**

- Be aware of the literature prior to designing and carrying out the experiments
- This literature will form the basis of your Introduction and Discussion.
- Perform on-line searches for the literature

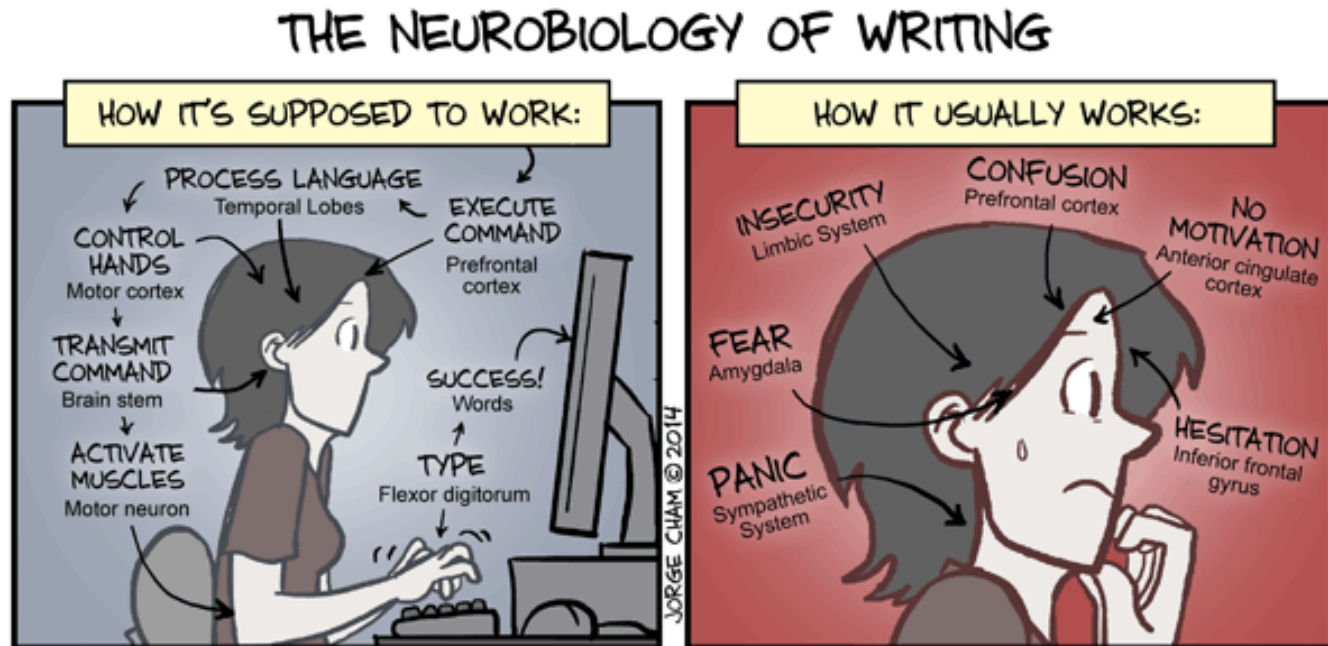

Sequence of Paper Writing: II

• Write the Results Section

- Your analyses should tell a "story" which leads the reader to logically answer the question(s)
- The order in which you present your results is important in convincing your readers
- Begin with designing the Figures and Tables
- Each Table or Figure conveys one (max two) key results
- Be sure to explain these results to the reader (don't assume *anything* about the reader)
- Use the text component to guide the reader through your key results
- Each Table and Figure must be referenced in the text portion of the results

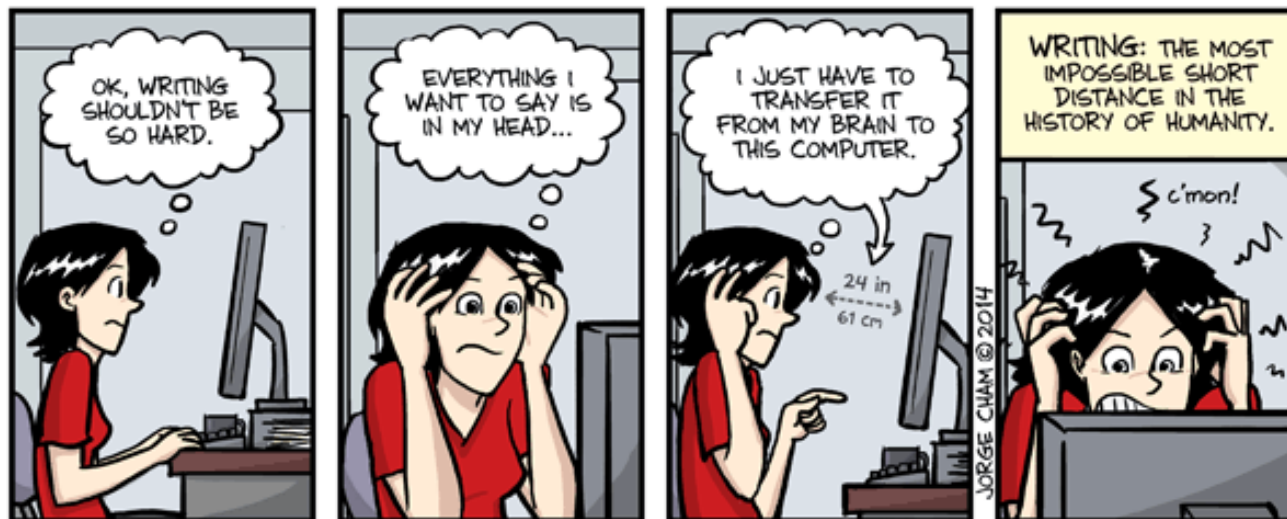

Sequence of Paper Writing: III

- **Write the Discussion**

- How your results modify and fit in with what we previously understood about the problem
- Review the literature again at this time
- Be sure to cite the works that you refer to
- Reconsider the Results Section, including Figures

- **Write the Conclusions**

- **Write a compelling Introduction**

- **Write the Materials and Methods (in fact, anytime)**

- Careful notes on procedures used during the experiment will certainly help!
- Do it upon completion of the experiments as an interim report

- **Write the Abstract and Title**

- The Abstract is always the last section written
- The Title will probably be written earlier, but is often modified

- **Here comes the 2nd iteration!**

Paper Improvements

• Self-Revise Your Paper

- Most authors revise their papers **at least 10-20x** before giving it out for peer review
- Go back over your paper and read it carefully
- Does it say what you wanted it to say?
- Do any ideas, experiments, or interpretations need to be moved around to enhance the logical flow of your arguments?
- Can you shorten long sentences to clarify them? (a sentence must be < 4 lines)
- Can you change passive verbs to active forms?
- Do the Tables and Figures have sufficient information to stand alone outside the context of the paper?
- Always have your spellchecker ON to catch typos

But I LOVE this paragraph. How can I delete it? It's some of my best writing ever! Ok, maybe it doesn't contribute to the overall story but I spent so long writing it! If single paragraphs could win the Pulitzer, this paragraph would win, for sure. Revision is overrated, and since I spent so much time on this paragraph. Why do I have to get rid of something that you can't make me? This paragraph is the best I



Peer review and Final draft

- **Peer Review**

- Have knowledgeable **colleagues critique** your paper
- Use their comments to **revise** your paper yet again

- **Prepare the Final Draft**

- Carefully **proof-read** your final draft to make sure its as well done as possible
- Double check that you have **proper references** in the text and in the References
- Check the **formatting** one last time



Before Submitting Check List: Part I

- **Global**

- check the **sequence** of ideas/background/content in each section for logical progression
- check for a strong **relationship of ideas** between the Introduction (*what we knew before our study*) and the Discussion (*how our study changes or supports our previous understanding*)

- **Each paragraph**

- check that each paragraph has a **coherent topic sentence**, most often as the lead sentence
- in each paragraph, do the **other sentences support the topic sentence?**
- check the **transitions between paragraphs** to ensure they are *logical* and *smooth*

- **Line editing**

- eliminate **superfluous lead phrases** (*Once that was done, ..*)
- remove all **colloquial (informal) language**
- check for **redundancy** (i.e. places where you repeat what you have said elsewhere)
- read each sentence closely for **clarity** and **brevity**. Can you say the same thing with fewer words?

Before Submitting Check List: Part II

- **Read the paper aloud** to find those quirky sentences that you wrote - if doesn't sound correct when spoken aloud, it will read even more oddly.
- **Miscellaneous**
 - check that all of your **sources are cited correctly** in the text
 - check the **numbering sequence of your tables and figures**
 - check the **Literature Cited** for completeness and correct format
 - check the **line spacing between headings and text**, and Tables and Figures and text
 - check the **page breaks** to make sure you do not split tables or figures
 - are the **authors' names** spelled correctly?
 - run spell check on the document to find **typographical errors** and read carefully for **spelling** and **grammatical errors**
 - check your main **headings and subheadings** for proper case and placement
 - check for **colloquial speech, slang**, or "childish" words or phrases; eliminate them
 - check for **contractions**: "don't" must be "do not" and "isn't" must be "is not" etc.
 - check for *consistent* and *correct* use of **terminology** ([70]PCBM vs PC₇₁BM)

Remember: a scientific paper *cannot* be completed but has to be brought it to an end!

Scientific Paper Cycle

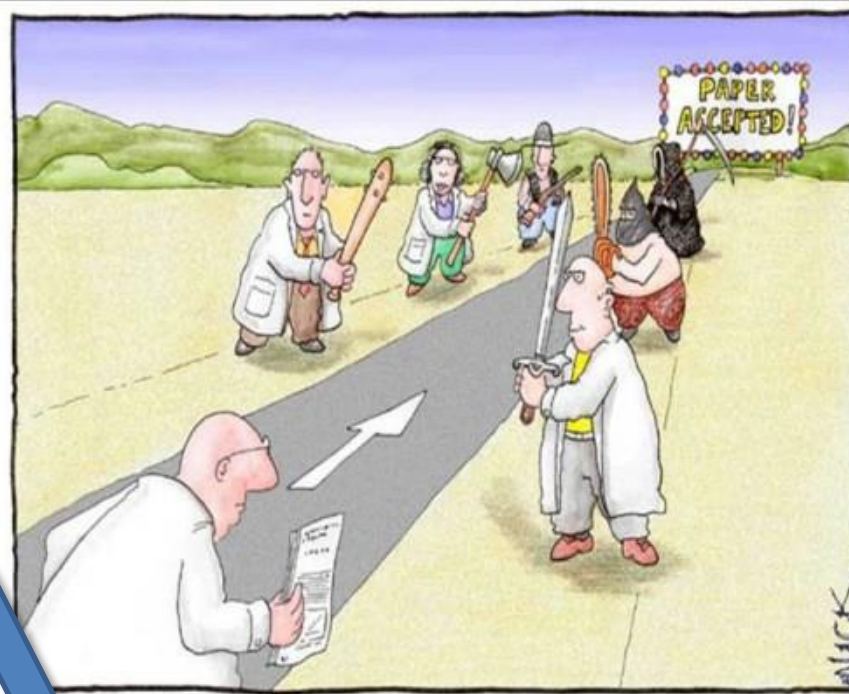
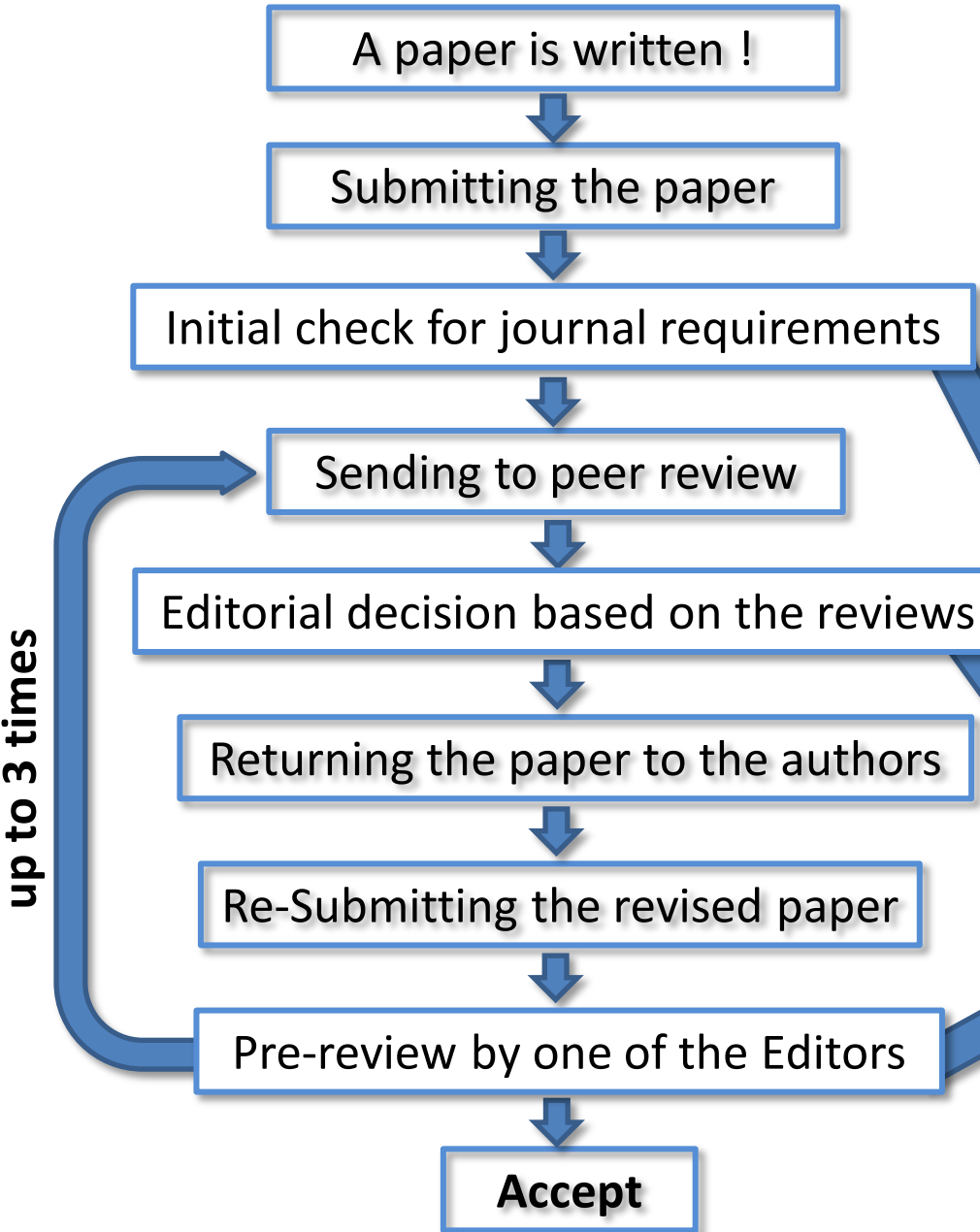

Reject !!!

*You have to learn to take the hit !
(but it always hurts)*

Where to Submit?

- **Decide on the journal**

- the paper is **suitable** for this journal
- receives **fair reviews**
- **become known** after having published

- **Audience: Who will be reading your paper?**

you would write a very different article for a narrow, highly technical, disciplinary journal vs. one that went out to a broad range of disciplines

- **Prestige, access and impact**

- **Publication speed**

- **Likelihood of acceptance**

Read journals' instruction for authors !



Tip 10 - Choice of journal: define a list of target journals!

Responding to Reviewers' Comments

- **Don't get frustrated!**

- use the comments **constructively to improve** the paper

- **Get organized**

- major comments (agree or not?)

- minor comments (rather agree)

- **You can disagree, as long as you explain**

- this is the essence of the scientific debate

- make it factual

- **Spell it out**

- copy paste each reviewer comment, and type your response below it

- be very specific

- **Use a balanced and collegial tone**

- **Don't forget to make the changes**



Tip 12 - Responding to reviewers: don't get frustrated!

Ladder of Humiliation

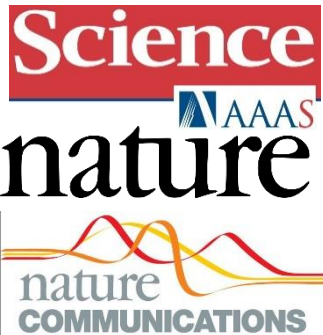

Science (35)
 Nature group (12-42)
 Nat Com (11)

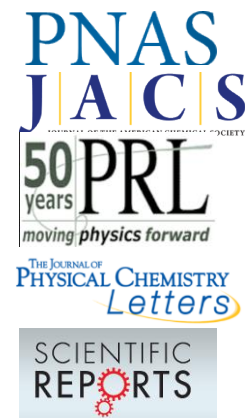

PNAS (10)
 JACS (13)
 PRL (8)
 PRX (8)
 JPCL (9)
 Sci Rep (5)



PR (1-4)
 APL (3)
 JPC (~4)
 JCP (3)
 PCCP (4)

...
 ...



REJECTED!

Rejected!

Rejected!

Writing in English as a Foreign Language

English is the international language of science

- **You and Editors are allies... BUT! you have to do your part of job!**
 - submit informative, well-organized and clearly written paper
 - do not put the language before more basic aspects!
- **Consider cultural differences**
 - directness of expression (straight vs go-around)
 - informative content of Methods (in-depth vs surface)
 - usage of others' material
 - complexity of the sentences (no Leo Tolstoy style)
- **Consider the grammar**
 - verb tenses
 - propositions
 - articles
- **Write simple, do not try to impress the reader!**
- **Ask somebody with strong English to review your paper**

William Safire's Rules for Writers

Remember to never split an infinitive

Verbs has to agree with their subject

Don't use no double negative

Avoid clichés like the plague

Do not use hyperbole; not one writer in a billion can use it efficiently

Just between you and I, case is important

About sentence fragments

A preposition is a terrible word to end a sentence with

Don't overuse exclamation marks!!!

Do not put statements in the negative form

Conclusions: Paper Structure at a Glance

Here we have presented general suggestion and tips for scientific paper writing

Experimental process

What did I do in a nutshell?

What is the problem?

How did I solve the problem?

What did I find out?

What does it mean?

What have I done? What are the implications?

Who helped me out?

Whose work did I refer to?

Extra Information

Section of Paper

Abstract

Introduction

Materials and Methods

Results

Discussion

Conclusions

Acknowledgments (optional)

References

Supplementary Materials

Generic structure of each paragraph, (sub)section, chapter, book etc

- **Why?** Provide the motivation of what you are going to do
- **How?** Describe how you did what you intended to do
- **So what?** Provide the conclusions and make a transition to the next part

A Postscript

My recommendations have been based on:

- what I do myself
- what I have not done myself
- what I would like to be done by my students
- what I observe other people do
- what other people recommend to do

Write your papers as I explained (but not how I do it!)

...and then rewrite this lecture to explain the new generation how to write even better

Literature

<http://profsite.um.ac.ir/~afotovat/imrad%20How%20to%20Write%20and%20Publish%20a%20Scientific%20Paper.pdf>

<http://www.bates.edu/biology/files/2010/06/How-to-Write-Guide-v10-2014.pdf>

How to write and publish a scientific paper, R.A. Day and B. Gastel, Greenwood 2011

How to write mathematics, P. R. Halmos, L'Enseignement Math. 16:2 (1970) 123-152

<https://www.mapsforthat.com/viewmap.php?m=2035>

<https://thinkscience.co.jp/en/articles/2016-06-WritingResponseLetters.html>

